



JASIC®

EVO2.0



Operator Manual

ET-200PACDC TFT-LCD



Your new product



Jasic.co.uk

Thank you for selecting this Jasic EVO 2.0 product.

This product manual has been designed to ensure that you get the most from your new product. Please ensure that you are fully conversant with the information provided paying particular attention to the safety precautions. The information will help protect yourself and others against the potential hazards that you may come across.

Please ensure that you carry out daily and periodic maintenance checks to ensure years of reliable and trouble free operation.

Please call your Jasic distributor in the unlikely event of a problem occurring. Please record below the details from your product as these will be required for warranty purposes and to ensure you get the correct information should you require assistance or spare parts.

Date purchased _____

From where _____

Serial number _____

(The serial number is normally located on the top or underside of the machine and will begin with AA)

For further information on your Jasic product warranty registration please visit:

www.jasic-warranty.co.uk

Disclaimer

Whilst every effort has been made to ensure that the information contained within this manual is complete and accurate, no liability can be accepted for any errors or omissions.

Please Note:

Products are subject to continual development and may be subject to change without notice. Regularly check our product pages at www.jasic.co.uk for revision updated operating manuals.

No part of this manual may be copied or reproduced by any means without the written permission of Wilkinson Star Limited.

CONTENTS

Index	Page
Your New Product	2
Index	3
Safety Instruction	4
Package Contents	9
Description of Symbols	10
Product Overview	11
Technical Specifications	12
Description of Controls	13
Installation	14
Description of the TFT-LCD Control Panel	17
Navigating the TFT-LCD Control Panel	22
Remote Control Option (wired and wireless)	33
MMA Setup	36
Operation MMA	37
Guide to MMA Welding	40
MMA Welding Troubleshooting	44
TIG Setup	45
Operation TIG DC	46
Operation TIG AC	52
TIG Torch Operation	58
Operation LIFT TIG	61
Guide to TIG Welding	62
TIG Torch Spare Parts List	73
TIG Welding Troubleshooting	75
Maintenance	78
Machine Troubleshooting (including error codes)	78
WEEE Disposal	80
RoHS Compliance Declaration	80
UKCA Declaration of Conformity	81
EC Declaration of Conformity	82
Statement of Warranty	83
Schematic	84
Optional LC-30 Water Cooler Information	85
Options and Accessories	86
Notes	87
Jasic Contact Details	88

SAFETY INSTRUCTIONS



These general safety norms cover both arc welding machines and plasma cutting machines unless otherwise noted. The user is responsible for installing and operating the equipment in accordance with the enclosed instructions.

It is important that users of this equipment protect themselves and others from harm, or even death. The equipment must only be used for the purpose it was designed for. Using it in any other way could result in damage or injury and in breach of the safety rules.

Only suitably trained and competent persons should operate the equipment.

Pacemaker wearers should consult their doctor prior to using this equipment.

PPE and workplace safety equipment must be compatible for the application of the work involved.

Always carry out a risk assessment before carrying out any welding or cutting activity.

General electrical safety



Danger
Electric shock risk

The equipment should be installed by a qualified person and in accordance with current standards in operation.

It is the users responsibility to ensure that the equipment is connected to a suitable power supply. Consult your utility supplier if required.

Do not use the equipment with the covers removed. Do not touch live electrical parts or parts which are electrically charged. Turn off all equipment when not in use.

In the case of abnormal behaviour of the equipment, the equipment should be checked by a suitably qualified service engineer.

If earth bonding of the work piece is required, bond it directly with a separate cable with a current carrying capacity capable of carrying the maximum capacity of the machine current.

Cables (both primary supply and welding) should be regularly checked for damage and overheating.

Never use worn, damaged, under sized or poorly jointed cables.

Insulate yourself from work and earth using dry insulating mats or covers big enough to prevent any physical contact.

Never touch the electrode if you are in contact with the work piece return.

Do not wrap cables over your body.

Ensure that you take additional safety precautions when you are welding in electrically hazardous conditions such as damp environments, wearing wet clothing and metal structures.

Try to avoid welding in cramped or restricted positions.

Ensure that the equipment is well maintained. Repair or replace damaged or defective parts immediately.

Carry out any regular maintenance in accordance with the manufacturers instructions.

The EMC classification of this product is class A in accordance with electromagnetic compatibility standards CISPR 11 and IEC 60974-10 and therefore the product is designed to be used in industrial environments only.

WARNING: This class A equipment is not intended for use in residential locations where the electrical power is provided by a public low-voltage supply system. In those locations it may be difficult to ensure the electromagnetic compatibility due to conducted and radiated disturbances.

General operating safety



Never carry the equipment or suspend it by the carrying strap or handles during welding.

Never pull or lift the machine by the welding torch or other cables.

Always use the correct lift points or handles. Always use the transport under gear as recommended by the manufacturer.

Never lift a machine with the gas cylinder mounted on it.

If the operating environment is classified as dangerous, only use S-marked welding equipment with a safe idle voltage level. Such environments may be for example: humid, hot or restricted accessibility spaces.

SAFETY INSTRUCTION

⚠ CAUTION Use of Personal Protective Equipment (PPE)

PPE REQUIRED AT ALL TIMES

Welding arc rays from all welding and cutting processes can produce intense, visible and invisible (ultraviolet and infrared) rays that can burn eyes and skin.

- Wear an approved welding helmet fitted with an appropriate shade of filter lens to protect your face and eyes when welding, cutting or watching.
- Wear approved safety glasses with side shields under your helmet.
- Never use any equipment that is damaged, broken or faulty.
- Always ensure there are adequate protective screens or barriers to protect others from flash, glare and sparks from the welding and cutting area.
- Ensure that there are adequate warnings that welding or cutting is taking place.
- Wear suitable protective flame resistant clothing, gloves and footwear.
- Ensure adequate extraction and ventilation is in place prior to welding and cutting to protect users and all workers nearby.
- Check and be sure the area is safe and clear of flammable material before carrying out any welding or cutting.



Some welding and cutting operations may produce noise. Wear safety ear protection to protect your hearing if the ambient noise level exceeds the local allowable limit (e.g: 85 dB).

Welding and Cutting Lens Shade Selector Guide

WELDING CURRENT	MMA ELECTRODES	MIG LIGHT ALLOY	MIG HEAVY METALS	MAG	TIG ALL METALS	PLASMA CUTTING	PLASMA WELDING	GOUGING ARC/AIR	
10	8	10	10	10	9	11	10	10	
15									
20									
30	9	10	10	10	10	11	11	10	
40									
60	10	10	10	10	11	11	11	10	
80									
100	11	11	11	11	12	12	12	12	
125				11					
150				12					
175	12	11	11	12	13	12	13	11	
200				13					
225				12					
250	13	12	12	13	13	13	13	12	
275									13
300									13
350	14	14	14	14	14	13	14	13	
400									14
450									14
500	15	15	14	15	15	13	14	15	

SAFETY INSTRUCTION

Safety against fumes and welding gases



Warning
Fumes and
Gases

The HSE have identified welders as being an 'at risk' group for occupational diseases arising from exposure to dusts, gases, vapours and welding fumes. The main identified health effects are pneumonia, asthma, chronic obstructive pulmonary disease (COPD), lung and kidney cancer, metal fume fever (MFF) and lung function changes.

During welding and hot cutting 'hot work' operations, fumes are produced which are collectively known as welding fume. Depending upon the type of welding process being performed, the resultant fume generated is a complex and highly variable mixture of gases and particulates. Regardless of the length of welding being carried out, all welding fume, including mild steel welding requires suitable engineering controls to be in place which is usually Local Exhaust Ventilation (LEV) extraction to reduce the exposure to welding fume indoors and where LEV does not adequately control exposure it should also be enhanced by using suitable respiratory protective equipment (RPE) to assist with protecting against residual fume.

When welding outdoors appropriate RPE should be used.

Prior to undertaking any welding tasks an appropriate risk assessment should be carried out to ensure expected control measures are in place.

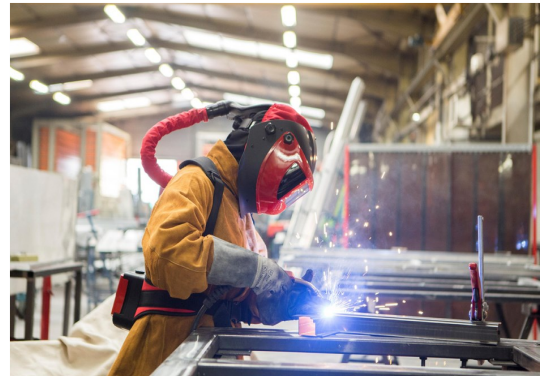

An example of personal fume protection

Locate the equipment in a well-ventilated position and keep your head out of the welding fume.

Do not breathe in the welding fume.

Ensure the welding zone is well-ventilated and provision should be made for suitable local fume extraction system to be in place.

If ventilation is poor, wear an approved airfed welding helmet or respirator.

Read and understand the Material Safety Data Sheets (MSDS's) and the manufacturer's instructions for metals, consumable, coatings, cleaners and de-greasers.

Do not weld in locations near any de-greasing, cleaning or spraying operations.

Be aware that heat and rays of the arc can react with vapours to form highly toxic and irritating gases.

For further information please refer to the HSE website www.hse.gov.uk for related documentation.

Precautions against fire and explosion



Caution
Risk of fire

Avoid causing fires due to sparks and hot waste or molten metal.

Ensure that appropriate fire safety devices are available near the welding and cutting area.

Remove all flammable and combustible materials from the welding, cutting and surrounding areas.

Do not weld or cut fuel and lubricant containers, even if empty. These must be carefully

cleaned before they can be welded or cut.

Always allow the welded or cut material to cool before touching it or

placing it in contact with combustible or flammable material.

Do not work in atmospheres with high concentrations of combustible fumes, flammable gases and dust.

Always check the work area half an hour after cutting to make sure that no fires have begun.

Take care to avoid accidental contact of the torch electrode to metal objects, as this could cause arcs, explosion, overheating or fire.

Know and understand your fire extinguishers

	Water	Foam spray	ABC powder	Carbon dioxide	Wet chemical
<i>Symbols found on fire extinguishers & what they mean</i>					
Flammable Wood, paper & textiles	✓	✓	✓	✗	✓
Flammable liquids	✗	✓	✓	✓	✗
Flammable gases	✗	✗	✓	✗	✗
Electrical contact	✗	✗	✓	✓	✗
Cooling oil & fats	✗	✗	✗	✗	✓

SAFETY INSTRUCTION

The working environment



Ensure the machine is mounted in a safe and stable position allowing for cooling air circulation.
Do not operate equipment in an environment outside the laid down operating parameters.
The welding power source is not suitable for use in rain or snow.

Always store the machine in a clean, dry space.

Ensure the equipment is kept clean from dust build up.

Always use the machine in an upright position.

Protection from moving parts



When the machine is in operation keep away from moving parts such as motors and fans.

Moving parts, such as the fan, may cut fingers and hands and snag garments.

Protections and coverings may be removed for maintenance and managed only by qualified personnel after first disconnecting the power supply cable.

Replace the coverings and protections and close all doors when the intervention is finished and before starting the equipment.

Take care to avoid getting fingers trapped when loading and feeding wire during set up and operation.

When feeding wire be careful to avoid pointing it at other people or towards your body.

Always ensure machine covers and protective devices are in operation.

Risks due to magnetic fields



The magnetic fields created by high currents may affect the operation of pacemakers or electronically controlled medical equipment.

Wearers of vital electronic equipment should consult their physician before beginning any arc welding, cutting, gouging or spot welding operations.

Warning
Strong magnetic field

Do not go near welding equipment with any sensitive electronic equipment as the magnetic fields may cause damage.

Keep the torch cable and work return cable as close to each other as possible throughout their length.

This can help minimise your exposure to harmful magnetic fields.

Do not wrap the cables around the body.

Handling of compressed gas cylinders and regulators



Mishandling gas cylinders can lead to rupture and the release of high pressure gas.

Always check the gas cylinder is the correct type for the welding to be carried out.

Always store and use cylinders in an upright and secure position.

Danger
Compressed gas

All cylinders and pressure regulators used in welding operations should be handled with care.

Never allow the electrode, electrode holder or any other electrically “hot” parts to touch a cylinder.

Keep your head and face away from the cylinder valve outlet when opening the cylinder valve.

Always secure the cylinder safely and never move with regulator and hoses connected.

Use a suitable trolley for moving cylinders.

Regularly check all connections and joints for leaks.

Full and empty cylinders should be stored separately.

Never deface or alter any cylinder

SAFETY INSTRUCTIONS

Fire awareness



The cutting and welding process can cause serious risks of fire or explosion. Cutting or welding sealed containers, tanks, drums or pipes can cause explosions. Sparks from the welding or cutting process can cause fires and burns. Check and risk assess the area is safe before doing any cutting or welding. Ventilate all flammable or explosive vapour from the workplace.

Remove any and all flammable materials away from the working area. If necessary, cover flammable materials or containers with approved covers (following manufacturers instructions) if unable to remove from the immediate area.

Do not cut or weld where the atmosphere may contain flammable dust, gas or liquid vapour. Always have the appropriate fire extinguisher nearby and know how to use it.

Hot parts



Always be aware that material being cut or welded will get very hot and hold that heat for a considerably long time which will cause severe burns if the appropriate PPE is not worn. Do not touch hot material or parts with bare hands.

Always allow for a cooling down period before working on material recently cut or welded. Use the appropriate insulated welding gloves and clothing to handle hot parts to prevent burns.

Noise awareness



The cutting and welding process can generate noise that can cause permanent damage to your hearing. Noise from cutting and welding equipment can damage hearing.

Always protect your ears from noise and wear approved and appropriate ear protection if noise levels are high. Consult with your local specialist if you are unsure how to test for noise levels.

RF Declaration



Equipment that complies with directive 2014/30/EU concerning electromagnetic compatibility (EMC) and the technical requirements of EN60974-10 is designed for use in industrial buildings and not for domestic use where electricity is provided via the low voltage public distribution system.

Difficulties may arise in assuring class A electromagnetic compatibility for systems installed in domestic locations due to conducted and radiated emissions.

In the case of electromagnetic problems, it is the responsibility of the user to resolve the situation. It may be necessary to shield the equipment and fit suitable filters on the mains supply.

LF Declaration



Consult the data plate on the equipment for the power supply requirements.

Due to the elevated absorbance of the primary current from the power supply network, high power systems affect the quality of power provided by the network. Consequently, connection restrictions or maximum impedance requirements permitted by the network at the public network connection point must be applied to these systems.

In this case, the installer or the user is responsible for ensuring the equipment can be connected, consulting the electricity provider if necessary.

SAFETY INSTRUCTION

Materials and their disposal



Welding equipment is manufactured with BSI published standards meeting CE requirements for materials which do not contain any toxic or poisonous materials dangerous to the operator. Do not dispose of the equipment with normal waste.



The European Directive 2012/19/EU on Waste Electrical and Electronic Equipment states that electrical equipment that has reached its end of life must be collected separately and returned to an environmentally compatible recycling facility for disposal.

For more detailed information please refer to the HSE website www.hse.gov.uk

PACKAGE CONTENTS AND UNPACKING

Supplied within your new Jasic EVO product package will be the following items with each model.

Use care when unpacking the contents and ensure all items are present and not damaged.

If damage is noted or items are missing, please contact the supplier in the first instance and before installing or using the product.

Record the product model, serial numbers and purchase date in the information section found on the inside front page of this operating manual.

Jasic EVO 200PACDC PFC TFT-LCD

- ET-200P ACDC PFC Power Source
- Air cooled TIG Torch
- MMA work lead
- Work Return Lead
- USB Stick with Operating Manual
- 2m Gas Hose c/w fittings

If a water cooled package is ordered, the additional items will be supplied:

- LC-30 Water Cooler
- Water cooled TIG Torch



Please Note: Package contents may vary depending on country location and package part number purchased

DESCRIPTION OF SYMBOLS



Read this operation manual carefully before use.



Warning in operation.



Single-phase static frequency converter-transformer rectifier.



1 ~ 50/60Hz

Symbol of single-phase AC power supply and rated frequency.



Can be used in the environment which has high risk of electric shock.

IP Degree of protection, such as IP23S.

U₁ Rated AC input voltage (with tolerance $\pm 15\%$).

I_{1max} Rated maximum input current.

I_{1eff} Maximum effective input current.

X Duty cycle, The ratio of given duration time/the full-cycle time.

U₀ No-load voltage, Open circuit voltage of secondary winding.

U₂ Load voltage.

H Insulation class.



Do not dispose of electric waste with other ordinary waste.



Electric shock risk warning.



Current unit "A"



Overheat protection indicator.



Overcurrent protection indicator.



VRD function indicator.



MMA mode.



LIFT TIG mode.

ϕ 3.2

ϕ 4.0

Selection of welding electrode diameter for MMA.



MMA current.



Hot start current of MMA.



Arc force of MMA.



Welding mode switching.



Other function switching.



Wireless indication.



Remote control.



Pairing of wireless remote controller.

T_{pre}

Pre-flow

I_s

Initial current

T_{up}

Up-slope time

I_p

Peak current

I_b

Base current

T_{down}

Down-slope time

I_f

Finish current

T_{post}

Post-flow time

T_{...}

Spot welding time



Hz

Pulse frequency



%

Pulse duty cycle



DC TIG mode



DC pulse TIG mode

Hz

Pulse frequency unit "Hz"



HF arc starting mode



Lift arc starting mode



Smart gas

PRODUCT OVERVIEW

This digital TIG 200P ACDC inverter welding machine feature advanced technology that provides excellent welding performance along with user experience. They provide a stable arc that is ideal for AC HF TIG, DC HF TIG, DC Lift TIG, pulse TIG and MMA which can weld carbon steel, low alloy steel, stainless steel, aluminium and other materials.

Moreover, they offer many adjustable TIG and MMA functions and features that makes these machine very durable and robust machines for a wide range of welding applications.

The unique electrical structure and air passage design inside the machine increases the dissipation of heat generated by power devices, thus improving the duty cycle of the machine.

Benefitting from the unique air passage, the equipment can effectively prevent damage to power devices and control circuits from dust drawn in by the fan, thus greatly improving the reliability of the equipment.

The unique TFT-LCD display offers the operator the optimum user experience for the welding processes offered, an optional ClearVision panel version is also available.



Features and functions that include:

- Welding processes that include: AC and DC HF TIG, Lift TIG and MMA.
- Multiple AC output waveforms, with mixed wave frequency and duty cycle including AC wave balance.
- The EVO range offers a robust, ergonomic design that includes Active Balancing Air Passage (ABAP).
- TFT-LCD display offers the user an enhanced operating experience with an easy to navigate control
- Inbuilt power factor correction (PFC) and generator friendly.
- Wide Voltage mains input, this technology allows these to fully operate on mains input supplies seamlessly between 95V ~ 265V AC with auto compensation for mains voltage fluctuation.
- ClearVision digital control user panel technology.
- Enhanced TIG features that include, dash-arc, pre/post gas timers, up/down slope control, 2T/4T and smart gas control for optimising shielding gas consumption.
- Inbuilt HF stabilising technology.
- The ET-200P ACDC comes with full TIG pulse control in AC and DC TIG modes.
- Features such as, quick factory reset function, auto sleep mode and Voltage Reduction Device (VRD).
- Fan on-demand technology, that not only prolongs the life span of the internal fan more importantly it reduces the accumulation of grinding dust drawn into the machine.
- Overcurrent and overheat protection.
- MMA features that include, arc force, hot start current and anti-stick that offer easy arc starting, low spatter, stable current which offers good weld bead shape making this machine ideal for a wide range of welding electrodes.
- Parameters are automatically saved on shutdown and are restored automatically upon restarting the machine.
- Wired remote control interface as standard via front panel mounted 9 pin socket.
- Wireless capable with optional wireless remote control devices available.
- Heavy duty 35-50mm dinse sockets.
- High quality finish to mouldings and handle.

TECHNICAL SPECIFICATIONS

Parameter	Unit	Jasic TIG ET-200PACDC PFC	
Rated input (U1)	V	AC 95 ~ 265V (50/60 Hz)	
		115V	230V
Rated input current (I _{eff})	A	MMA 18.7 TIG 16.1	MMA 12.4 TIG 10.6
Rated input current (I _{max})	A	MMA 34.1 TIG 32.2	MMA 22.7 TIG 21.1
Rated input power	kVA	MMA 3.9 TIG 3.5	MMA 5.6 TIG 4.7
Welding current range	A	MMA 10 ~ 120 TIG 5 ~ 160	MMA 10 ~ 160 TIG 5 ~ 200
Welding voltage range (U2)	V	MMA 20.4 ~ 24.8 TIG 10.2 ~ 16.4	MMA 20.4 ~ 27.2 TIG 10.2 ~ 18.0
Rated duty cycle (X) (rated at 40°C)	%	MMA 120A @ 25% TIG 160A @ 25%	MMA 160A @ 30% TIG 200A @ 25%
Arc force current range	A	0 ~ 40	
Hot start current range	A	0 ~ 80	
Pre-flow time	S	0 ~ 3	
Post-flow time	S	0 ~ 15	
Initial and final current	A	5 ~ 160	5 ~ 200
Base current	A	5 ~ 160	5 ~ 200
Up/down slope time	S	0 ~ 10	
Pulse Frequency DC	Hz	0.5 ~ 200	
Pulse Duty	%	10 ~ 90	
AC Output Frequency	Hz	20 ~ 250	
AC Pulse Frequency	Hz	0.5 ~ 25	
AC Balance	%	20 ~ 60	
Spot Welding Time	S	0.1 ~ 10	
No load voltage (U0)	V	65	
VRD voltage (U _r)	V	11.5	
Arc start mode	-	HF / Lift	
Efficiency	%	80	
Idle State Power	W	< 50	
Power factor	cosφ	0.95	
Standard	-	EN60974-1	
Protection class	IP	IP23S	
Insulation class	-	H	
Noise	Db	< 70	
Operating Temperature range	°C	-10 ~ +40	
Storage temperature	°C	-25 ~ +55	
Size (with handle)	mm	490 x 165 x 341	
Net weight	Kg	11.9	
Overall weight	Kg	16.8	

DESCRIPTION OF CONTROLS - JASIC TIG ET-200P ACDC

Front view Jasic TIG ET-200P ACDC

1. Machine carry handle
2. Digital user control panel (see lower down for further information)
3. Wireless remote control (optional)
4. "+" Output terminal*, The connection for the work clamp in TIG mode
5. Shielding gas outlet connector
6. "-" Output terminal*: The connection for the TIG torch in TIG mode
7. Wired remote control 9 pin socket

* Panel socket size is 35/50mm

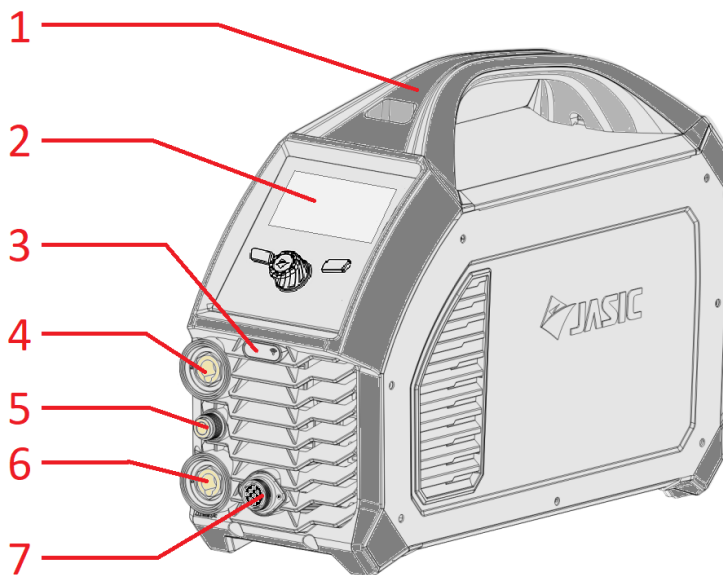

Rear view Jasic TIG ET-200P ACDC

8. Machine carry handle
9. ON/OFF power switch
10. Shielding gas inlet connector
11. Cooler control socket outlet
12. Rear panel with integrated cooling vents
13. Input power cable

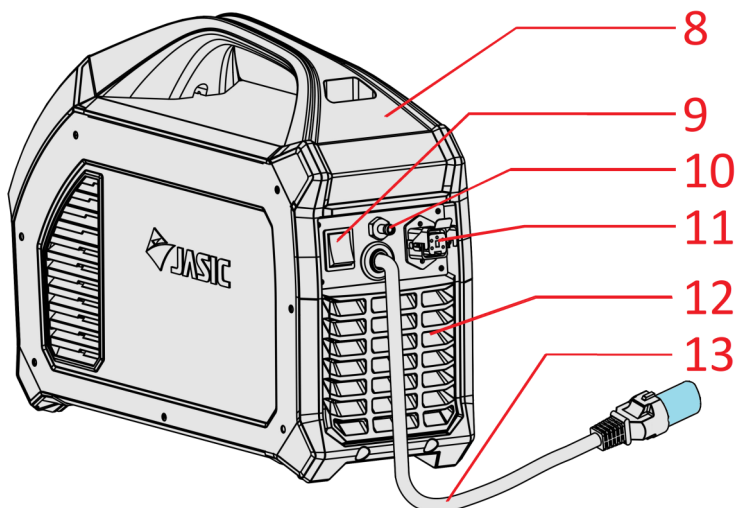

Front control panel view Jasic TIG ET-200P ACDC

14. Home Button: Pressing the home button will take you directly back to the home screen (as shown in the display area image on page 17)
15. The parameter control dial is also a control button which when pressed 'confirms' entry to another screen option or the chosen parameter being set.
16. LCD screen: The 5" colour display area shows the various welding mode options, the associated welding parameter, error codes, user manual to to the operator. During machine boot up The screen will show the Jasic logo (as shown right)
17. Return button: Pressing the return button takes the user back to the previous screen or option.
18. Parameter adjustment control dial: By rotating this control dial allows the user to scroll through or to make parameter changes that are shown via the display screen



INSTALLATION

Installation

The owner/user are responsible for installing and using this welding machine according to this operating manual.

Before installing this equipment, the owner/user shall make an assessment of potential hazards in the surrounding area.

Unpacking

Check the packaging for any signs of damage. Contact your supplier in the first instance if any item is missing or damaged. Carefully remove the machine and retain the packaging or at least until the installation is complete.

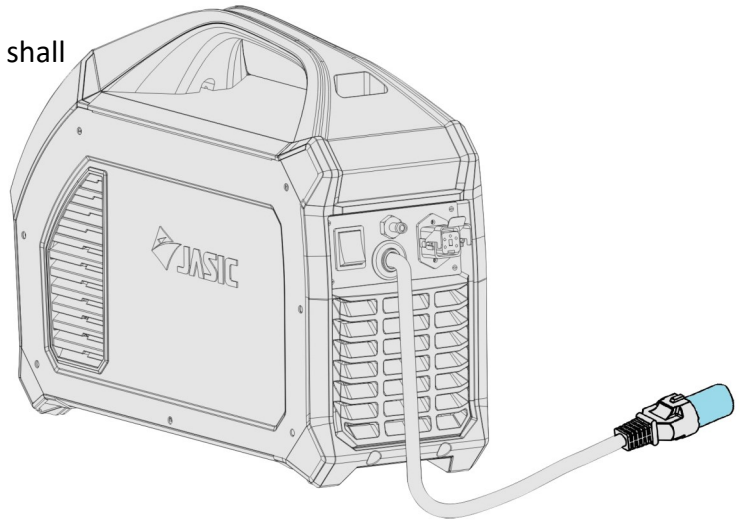

Lifting

The Jasic ET-200P ACDC does have an integrated handle for easy hand lifting only. Always ensure the machine is lifted and transported safely and securely.

Location

The machine should be located in a suitable position and environment. Care should be taken to avoid moisture, dust, steam, oil or corrosive gases. Place on a secure level surface and ensure that there is adequate clearance around the machine to ensure natural airflow. Do not use the system in rain or snow. Position the welding power supply near an appropriate power point ensuring you leave at least 30cm of space around the machine to allow for proper ventilation.

Always place the machine on a firm level surface before using, ensuring it cannot tip over. Never use the machine on its side.

Most metals including stainless steel can give off toxic fume when welded or cut.

To protect the operator and others working in the area its important to have adequate ventilation in the work area to ensure air quality level meets all local and national standards.

Warning!



The following operation requires sufficient professional knowledge on electric aspects and comprehensive safety knowledge. All connections shall be made with the power supply turned off. Incorrect input voltage may damage the equipment.

Electric shock may cause death; after switching off the machine, there are still high voltages within the machine, so if removing the covers do not touch any of the live parts on the equipment for at least 10 minutes. Never connect the machine to the mains supply with the panels removed.

The electrical connection of this equipment shall be carried out by suitably qualified personnel and these shall be made with the power supply off. Incorrect voltage may damage the equipment.

Input power connection

Before connecting the machine you should ensure that the correct supply is available.

Details of the machine requirements can be found on the data plate of the machine or in the technical specification table shown on page 12 within this manual.

This equipment should always be connected by a qualified competent person.

Always ensure the equipment is correctly grounded.

INSTALLATION

Input Power Connection continued

1. Test with multi-meter to ensure the input voltage value is within the specified input voltage range.
2. Ensure the power switch of the welder is turned off.
3. Wire the input mains cable wires to the correct sized mains plug, ensuring the live, neutral and earth (ground) wires are connected correctly.
4. Carry out an electrical test of the machine if required (i.e. PAT test)
5. Ensure that the input fuse is correctly rated for the machine.
6. Connect the machine mains power plug firmly to the corresponding supply socket.

Please Note!



If the machine needs to be operated on long extension leads, then please use an extension lead where the cable has a larger cross-sectional area to reduce the voltage drop. Please consult your electrician or electrical supplier for the recommended size.

Gas Connections

The gas regulator is designed to reduce and control the high pressure gas from a cylinder or pipeline to the working pressure required for the Jasic TIG machine.

Before fitting the regulator, clean the cylinder valve outlet.

Match the regulator to cylinder and before connecting, ensure the regulator and the regulator inlet and cylinder outlet match. Connect the regulator inlet connection to cylinder and tighten it firmly (do not over-tighten) with a suitable spanner. If using a flowmeter, connect to the regulator outlet. Connect the gas hose to the regulator/flowmeter which is now located on the shield gas cylinder and connect the other end to the Jasic machine.

With the regulator connected to cylinder, always stand to one side of regulator and only then slowly open the cylinder valve.

Slowly turn adjusting knob in (clockwise) direction until the outlet gauge indicates that you have set the required flow rate. To reduce flow rate, turn the adjusting screw anti-clockwise, until the required flow rate is indicated on the gauge/flow meter.

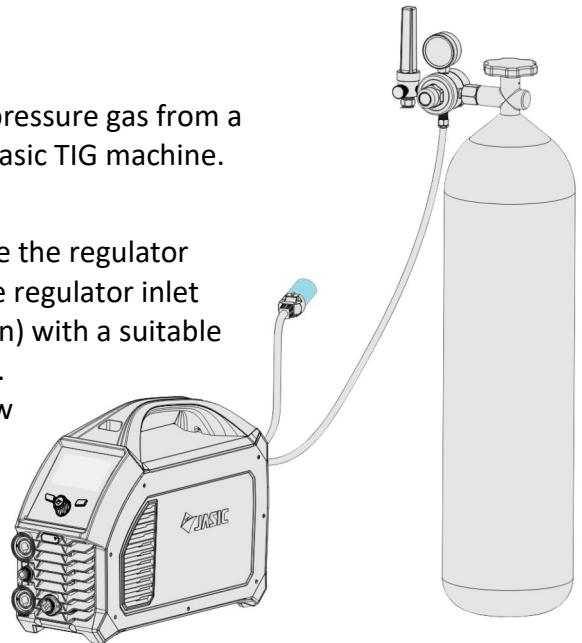

Output Power Connections

When inserting the cable plug of the work return lead, MMA electrode holder or TIG torch adapter into the dinse socket on the front panel of the welding machine, rotate it clockwise to tighten.

It is very important to check these power connections daily to ensure they have not become loose otherwise arcing may occur when used under load.

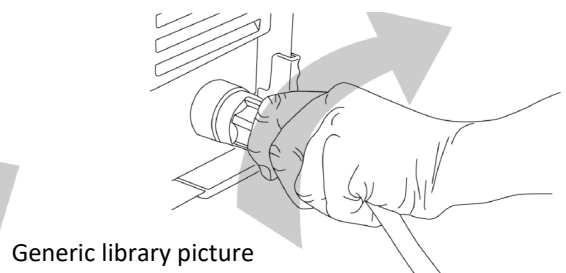
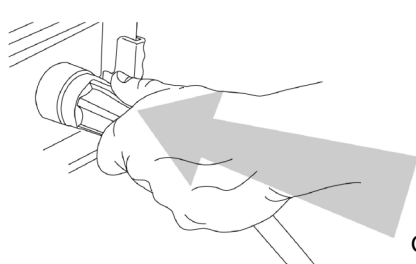

Generic library picture

INSTALLATION OF WIRED/WIRELESS REMOTE CONTROLS

Wired hand-held remote-control connection

As standard the EVO TIG 200P ACDC machine is fitted with a 9 pin remote control socket (1). This allows for the matching 9 pin plug (2) of the hand held remote control or foot pedal to be connected directly to the machine to offer the user remote operation control.

PLEASE NOTE:

Check that the machine supports a wired hand-held or foot remote control before installation.

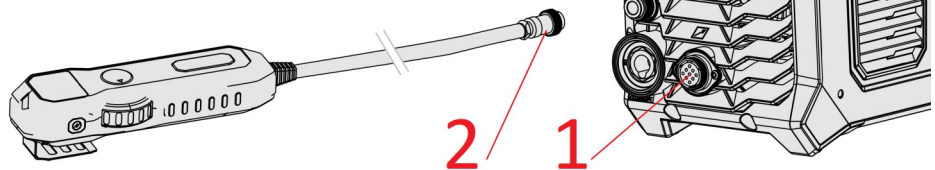

WIRELESS REMOTE CONTROL (OPTIONAL)

Wireless hand-held remote-control connection

An option with the EVO TIG range of machines is for the operator to be able to wirelessly control the welding current. To enable this, you will require to fit the optional remote interface module.

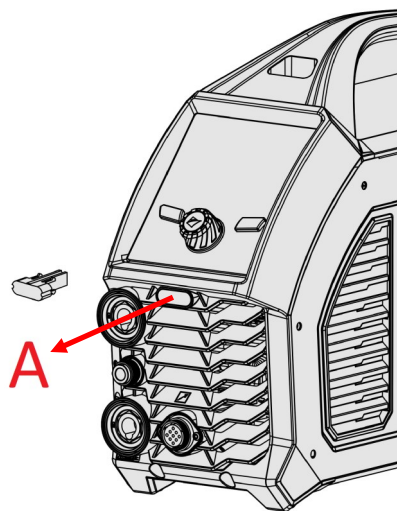

Installation of the wireless receiver module

- 1) Remove the plastic cap 'A' shown in the image right and fit the wireless receiver module as shown.
- 2) Remove the screws of the left side cover of the machine.
- 3) Remove the buckle from inside the front panel of the machine and pull out the plug.
- 3) Insert the wireless receiver module 'B' to the front panel, and then connect the connection line of the receiver module to the CN10 socket on the main board.

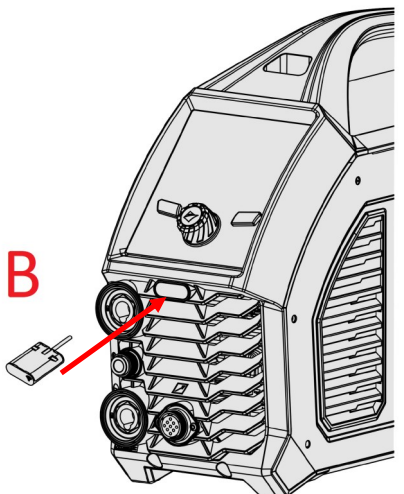

PLEASE NOTE:

Please check that the machine supports wireless hand held or foot remote controls before installation.

See page 34 for further information.



The above operation requires sufficient professional comprehensive knowledge of electrical circuits and electrical safety. Make sure the input cable of the machine is disconnected from the electricity supply and wait for 5 minutes before removing the machine covers.

DESCRIPTION OF 'LCD' CONTROL PANEL

Display screen

The display screen offers the operator a wealth of information including operation modes, a vast array of TIG DC/TIG AC and MMA parameters. The home screen is shown right and using the adjustment dial allows you to navigate through the machines options and the following pages will explain in greater details these features.

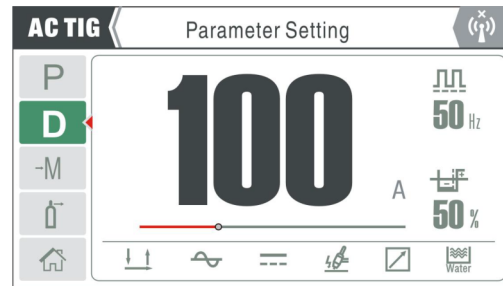

Parameter adjustment knob

Rotating the control dial clockwise or anti-clockwise allows the operator to scroll through the functions of the machine, increases or decreases parameter values including welding current and when these parameters are adjusted the values are shown in the display screen.



Home Button

Pressing the home button at any time will take directly back to the home screen which is shown in the display screen image below.



Return Button

The return button will take you back to the previous screen and the 'upper' level of the function you were within.



Display screen options

Home Screen

Upon pressing the Home button  you will be taken to the home screen (as shown right), default setting for selection is AC TIG, from here you can rotate the control dial to highlight the option you require and to select, simply press the control dial to access: welding mode, settings or operating information.

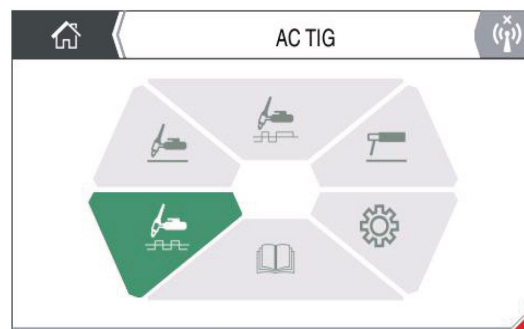

Selecting TIG Welding Modes

Before commencing any welding, press the Home button to return to the home page then rotate the control dial to select either TIG AC, TIG DC, TIG AC MIX welding mode, then press the control dial to select the required welding mode (see page 28 for further details).

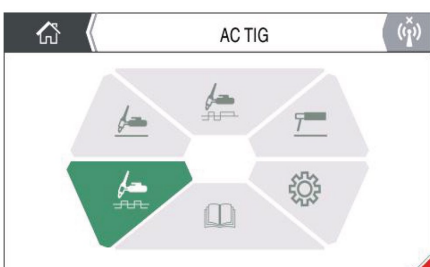

TIG AC Welding Mode

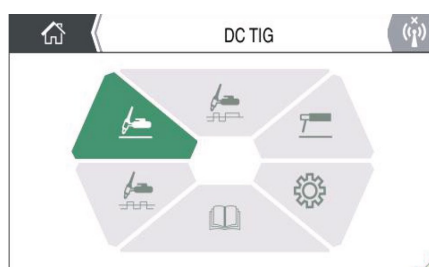

TIG DC Welding Mode

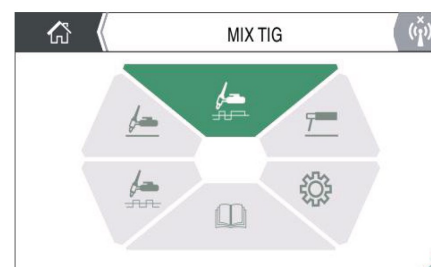

TIG AC Mix Welding Mode



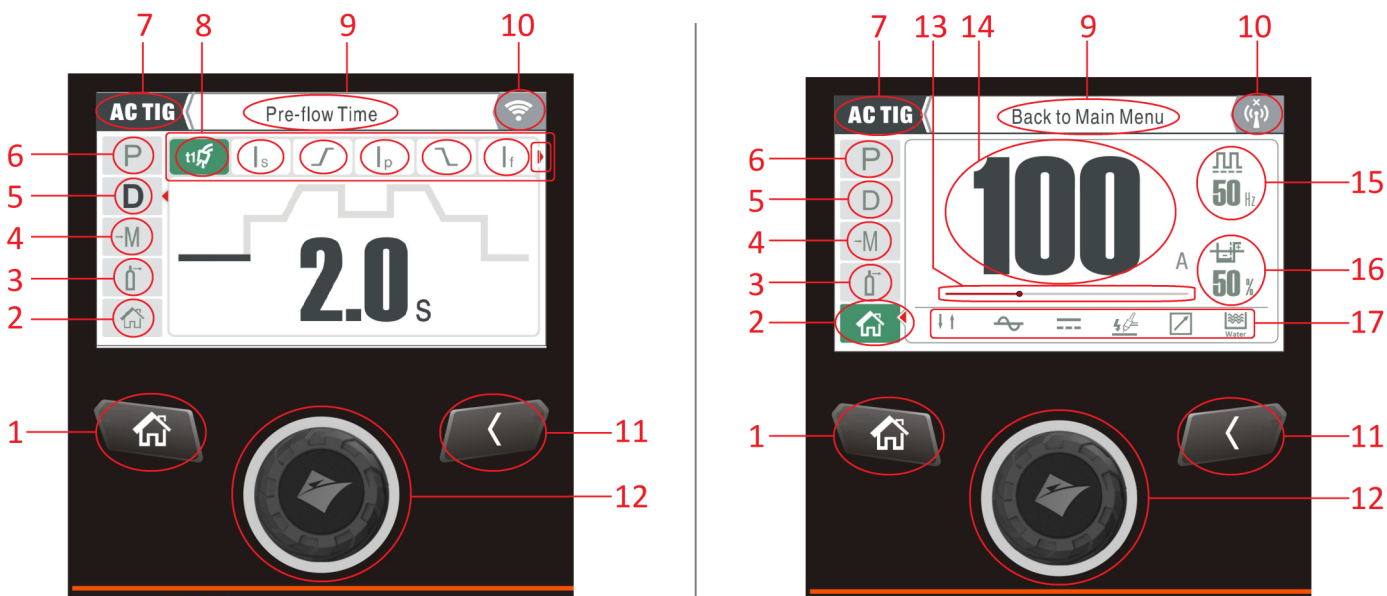













LCD SCREEN ICON FUNCTION DESCRIPTIONS

















The above control panel images are examples of screen modes you will come across during normal use of the Jasic ET-200P ACDC LCD machine and the below and following pages offer a brief explanation for the icons used.

Item No	Icon		Icon image description
1		Home button	Pressing the 'Home' button will return you to the main menu "Home" screen (as shown on page 22) and following pressing the button the AC TIG option will be highlighted by default.
2		Home icon	When rotating the control dial (item 12) for parameter or mode selection you will note as passing that the selected icon will highlight green, if you then press the control dial button (item 12) in this case the home icon, you will be taken to the home screen. The highlighted icon detail will also be stated in the text area (item 9) top center of the screen.
3		Gas check function	When in a TIG welding mode, rotate the control dial (item 12) until the gas check symbol lights up green, then press the control dial button to enter and activate gas purge, after 20s, the system will automatically exit the gas check function and return to the previous menu. During gas check, if you press any key, you will exit the gas check function.
4		Memory function	When in either TIG or MMA mode the machine can store 4 memory channels for each welding mode (machine total being 16). Rotate the control dial until the -M symbol lights up and press the control button. You will note that the header shows 4 channel slots with the header stating the channel number with the relevant parameters displayed. From here you can save, load and delete.







LCD SCREEN ICON FUNCTION DESCRIPTIONS

Item No	Icon	Icon Description	Brief Meaning of Setting
5		Parameter Settings	When in either of the TIG modes, D (Parameter settings) is a secondary menu where the TIG welding parameter additional functions can be adjusted and set. For example: pre/post gas, up/down slope, AC frequency, pulse and more.
		Pre Gas Time	Pre-flow time icon, indicates the gas pre-flow time which can be adjusted between 0 ~ 3 seconds.
		Initial (Start) Current	Initial current icon that indicates the start current mode. The start current adjustment range is 20 ~ 200 amps.
		Current Upslope Time	Upslope time icon, indicates the time set for the initial current to reach the peak current when welding, the adjustment range is 0 ~ 10 seconds.
		Peak Welding Current	Peak welding current icon which indicates the preset welding current during operation the range being 5 ~ 200 amps.
		Base Welding Current	Base (low pulse) welding current icon, an option only shown in pulse mode that indicates the base current setting, the low pulse current range is 20 ~ 200 amps.
		Current Downslope Time	Downslope time icon, indicates the time set for the initial current to reach the peak current, the adjustment range is 0 ~ 10 seconds.
		Final (Crater) Current	Initial current icon that indicates the final (crater) current mode. The final current adjustment range is 20 ~ 200 amps.
		Post Gas Time	Post-flow time icon, indicates the gas post-flow time which can be adjusted between 0 ~ 15 seconds.
		AC Frequency	AC frequency icon, indicates the AC frequency when in AC TIG Mode which has an adjustable range of 20 ~ 250Hz.
		AC Balance	AC balance icon, indicates the AC wave balance of tungsten anode time to AC cycle, which has an adjustable range of 20 ~ 60% with the mid point being 40%.
		Pulse Duty Ratio	Duty-ratio icon that indicates the ratio of the peak current time to the pulse period, the adjustment range of 10 ~ 90%.
		Pulse Frequency	Pulse frequency icon that indicates the pulse frequency can be adjusted and set between the range of 0.5 ~ 200Hz.
		Spot Time	Spot welding time icon which allows the user to adjust the spot welding time of between time of 0.1 ~ 10 seconds.
		Mix Frequency	Mixed frequency icon, indicates the mixed AC frequency when in MIX TIG mode, the adjustment range being 1 ~ 25Hz.
	Mix Duty Ratio	Mixed duty-cycle icon, indicates the ratio of DC time to the mixed period, adjustment range being 5 ~ 95%.	

LCD SCREEN ICON FUNCTION DESCRIPTIONS

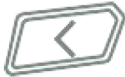
Item No	Icon	Icon Description	Icon image description
6		Function settings	When in either of the TIG modes, P (function settings) is a secondary menu where additional functions can be adjusted and set. For example: Trigger mode, HF or Lift TIG, Waveform, air/water cooled setting.
		2T	This icon represents 2T torch trigger mode, when this trigger option is selected it indicates the machine is in 2T mode.
		4T	This icon represents 4T torch trigger mode, when this trigger option is selected it indicates the machine is in 2T (latch) mode.
		Cycle Mode	This icon represents cycle (repeat) torch trigger mode, selecting this trigger option indicates the machine is in cycle mode.
		Spot Mode	This icon represents spot time trigger mode, selecting this trigger option allows the user to spot weld.
		HF TIG	HF TIG starting mode icon, allows the user to select and use HF arc start ignition when in DC or AC TIG welding mode.
		LIFT TIG	LIFT TIG starting mode icon, allows the user to select and use contact arc start ignition when in DC or AC TIG welding mode.
		Pulse Mode OFF	Pulse OFF icon indicator. When the icon is selected when TIG welding AC or DC pulse mode is turned OFF.
		Pulse Mode ON	Pulse ON icon indicator. When this icon is selected when TIG welding AC or DC pulse mode is turned ON.
		AC TIG Square wave	AC square wave provides fast transitions which provide a responsive and dynamic arc allowing for faster travel speeds
		AC TIG Sawtooth Wave	The triangular wave provides the required peak amperage but the waveform shape has the effect of reducing heat input. This reduction in heat input makes it well suited for thin materials.
		AC TIG Sinusoidal Wave	The sine wave gives the operator a softer feel arc similar to that of older conventional power source. The arc tends to be much wider than the square wave arc.
		Air Cooled Mode	This icon represents that Air Cooled mode has been selected, meaning no water cooler is connected and an air cooled TIG torch is fitted.
		Water Cooled Mode	This icon represents that Water Cooled mode has been selected, meaning a water cooler is connected and a water cooled TIG torch is fitted.
7		Screen Mode Section	English by default. This area displays which home mode option is currently selected, i.e. DC TIG, AC TIG, MIX TIG, MMA, Settings and User Guide.

LCD SCREEN ICON FUNCTION DESCRIPTIONS

Item No	Icon	Icon Description	Icon image description
8	---	Top Icon Bar	This multiple icon bar will show various secondary icon/options when you select and enter either Function Setting (P), Parameter Settings (D) or Memory (-M) options.
9	---	Function Description	English by default. This area displays and explains the current selected operation which is normally highlighted in green.
10		No Wireless Connection	This wireless icon is displayed when no wireless remote control device is connected to the machine.
		Wireless Connection Icon	The "Pairing successful" icon will be displayed when a wireless remote control device has been connected to the machine.
11		Back Button	Pressing the back button will take you to the previous screen or previous menu.
12		Control Dial	Rotating the control dial clockwise or anti-clockwise allows the user to navigate around the options, adjust welding current or the various welding parameters that are available.
		Control Button	The control button function is activated by pressing the front face of the control dial which 'enters/acknowledges the selected function on the screen.
13	---	Progress Bar	When welding current is displayed and rotating the control knob to adjust the welding current as you increase or decrease the current value you will note that the progress bar adjusts proportionally with the current preset value.
14	---	Parameter Setting	When numbers or values are highlighted, rotating the control dial clockwise or anti-clockwise allows the user to increase or decrease the value of the parameter or in the case of the image examples on page 18, the welding current shown is 100amps or the pre-gas time of 2 seconds.
15		AC Frequency Icon & Setting	In AC mode, the display represents AC frequency that allows the user to make quick adjustments during operation.
16		AC Balance Icon and Setting	In AC mode, this display represents AC balance which allows for quick balance adjustment that can be made by the user during operation.
17	---	Bottom Icon Bar	This multiple icon bar shows the operator a quick view of the 'background' set parameters, as per example shown on page 18 for AC TIG (from left to right) parameters are set as follows: 2T trigger mode, AC sine waveform, pulse mode ON, HF start, remote control ON and water cooled enabled. The icons shown can change depending on which TIG welding mode is selected.

NAVIGATING THE 'LCD' CONTROL PANEL

On powering up the machine and prior to commencing to weld, press the "Home" button to return to the home page (as shown below) by rotating the control dial you can then select either:

- AC TIG
- DC TIG
- MIX TIG
- MMA

then pressing the control dial will select and take you to the required welding mode parameters.

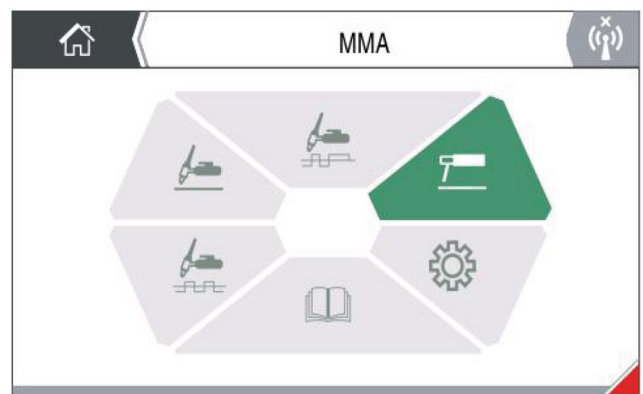
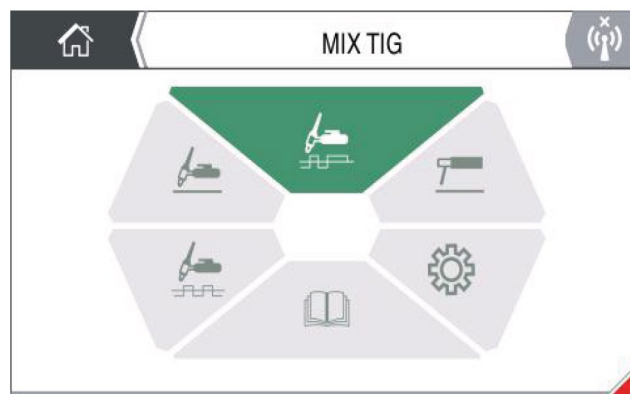
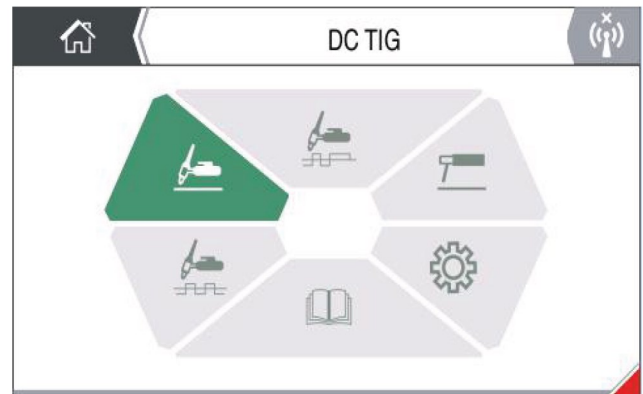
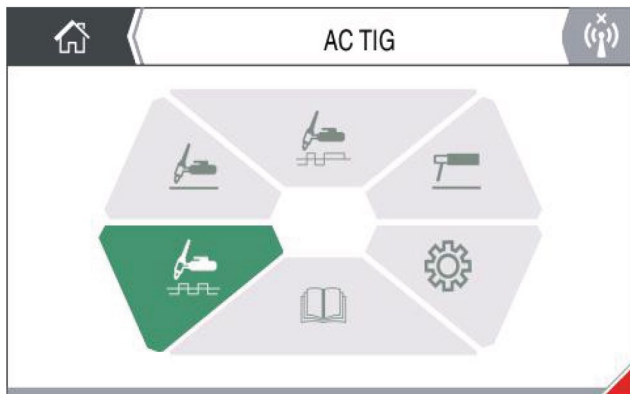

In addition to the four welding modes, there are two other options in the Home page:

- System Settings
- User Manual

Select the required option, rotate and press the control dial to enter the corresponding page option.

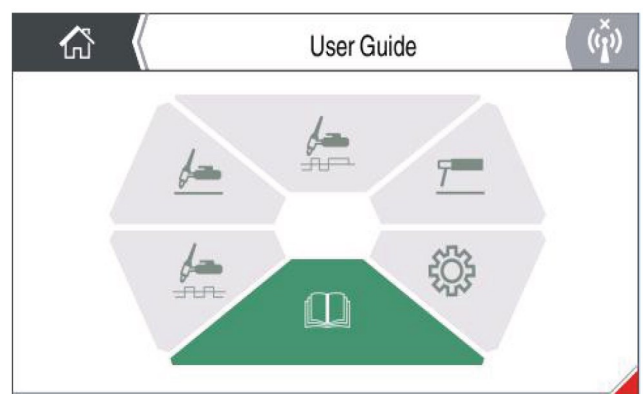
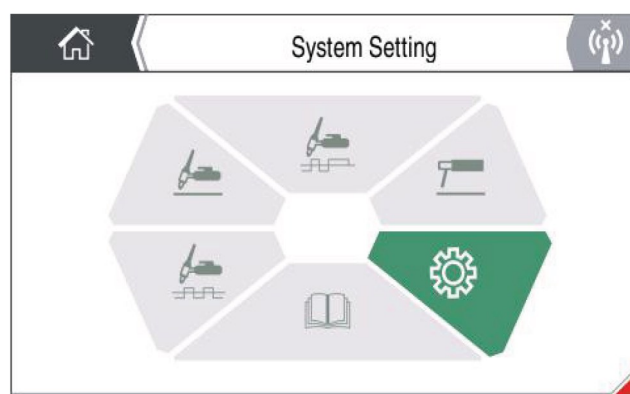

NAVIGATING THE 'LCD' CONTROL PANEL

Gas check (purge) function

When in either AC TIG, DC TIG or MIX TIG welding modes and prior to welding you can activate the gas flow function, this allows the user to check and set the gas flow.

With the machine connected to the shielding gas supply, navigate to the gas purge option by rotating the control dial until the gas purge icon is highlighted green (as shown below).

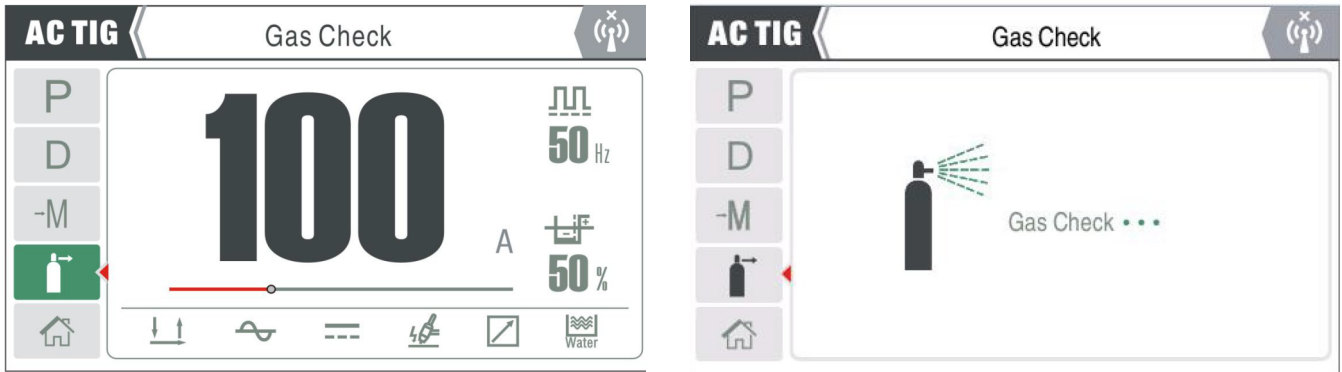

Pressing the control dial button once will activate the gas valve, the screen will change to show and state 'gas check' mode has activated and gas flow through the machine and TIG torch will commence, then pressing the control dial button again will turn off the gas flow.

Please Note: If you just press and release this button the gas will purge for 30 seconds and then turn off automatically.

Channel Storage, Recall or Delete

When in either AC TIG, DC TIG, MIX TIG or MMA welding mode and prior to welding you can select a saved welding job or save a welding job to and from the Memory function page.

Once in the memory page, you will note there are 4 memory slots to Select "M1", "M2", "M3" and "M4" and if a welding job was saved to any of the 4 welding slots the saved welding parameters will be displayed when you select a memory slot.

Rotating and pressing the control dial on the desired memory slot will then take you to the specific memory slot option page where you have three options of: "Save", "Load" or "Delete". Selecting your desired option is carried out by rotating the control dial and (for example) pressing the "Load" option recall the saved welding parameters and load said program.

Pressing the back button will take you to the recalled welding screen where you can then commence your welding procedure.

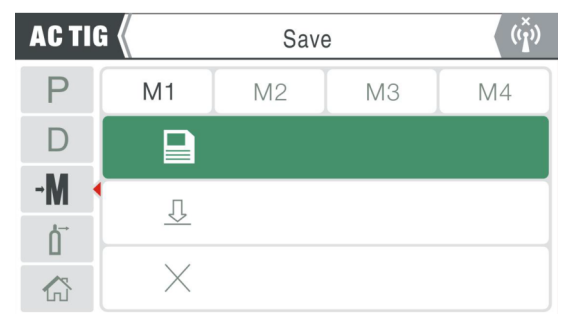
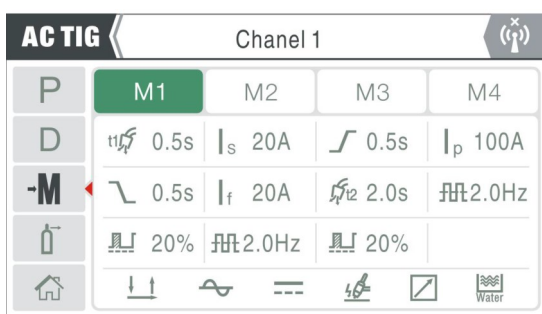
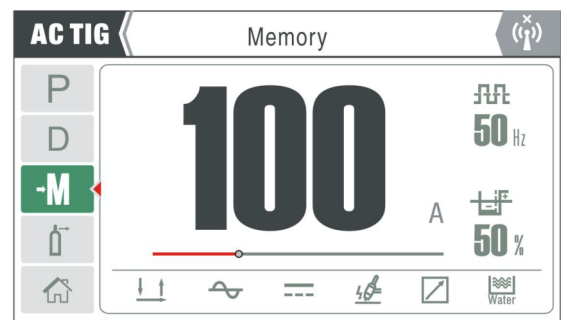

NAVIGATING THE 'LCD' CONTROL PANEL

Welding Parameter Setting - Selection and Adjustment

Upon selecting your required welding mode, which could be either AC TIG, AC TIG, MIX TIG or MMA from the "Home" page and for example we will continue to use AC TIG (as shown right). When AC TIG has been selected and then immediately rotating the control dial clockwise or anticlockwise will automatically increase or decrease welding current, this is because pre-set welding current is highlighted green.

To access and adjust AC TIG welding parameters, press the control dial button which now highlights the pre-set welding current area in a raised rectangle (as shown right).

The welding Parameter Setting access icon is identified by the 'D' symbol and rotating the control dial clockwise or anticlockwise will scroll you through all accessible options which are noted by being highlighted green, once the 'D' icon is highlighted, then press the control dial button to enter the welding parameter settings page.

On entering the Parameter Settings screen, you will note a row of welding parameter icons and the pre-flow icon is automatically highlighted green.

Rotating the control dial clockwise will scroll you through the available AC TIG welding parameters, rotating the dial anti-clockwise will then take you back through the parameters until 'D' is highlighted again.

Rotate the dial until pre-gas is highlighted green and press the control dial button to enter pre-gas time adjustment.

Once you have entered pre-gas time adjustment, you will see that the pre-gas time (as shown right) is now highlighted green. Now rotating the control dial clockwise or anticlockwise will automatically increase or decrease the pre-flow gas time and this is noted in second.

Once set, pressing the control dial button will save your chosen setting and return you to the previous setting of highlighting the pre-flow icon green where you can then rotate the control dial to select the next parameter setting you wish to adjust.

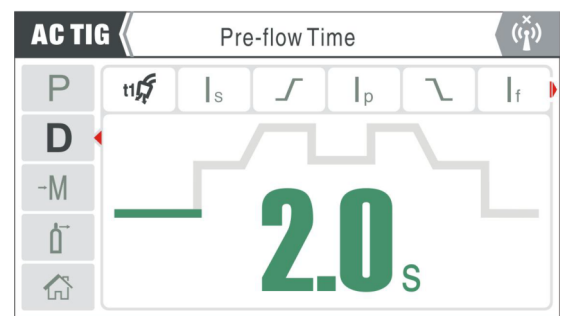
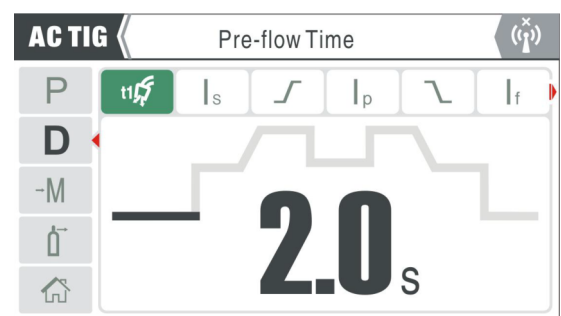
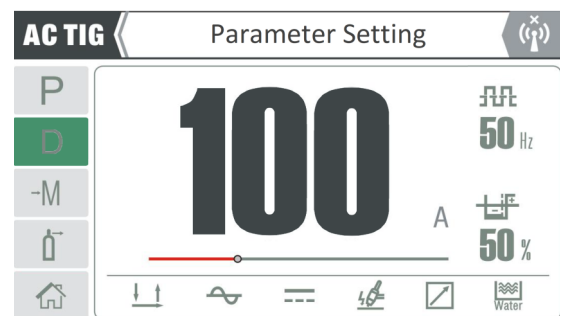
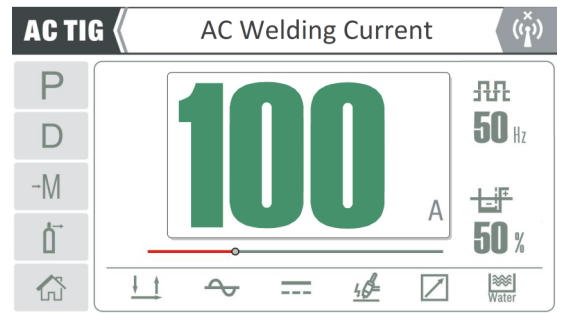
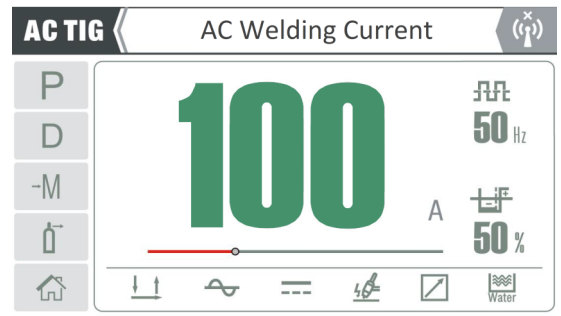

For further information on welding parameter choice, settings and description, please go to page 19.

NAVIGATING THE 'LCD' CONTROL PANEL

Welding Function Setting - Selection and Adjusting

As per previous page, to access and adjust AC TIG Function Settings, press the control dial button which now highlights the pre-set welding current area in a raised rectangle (as shown right).

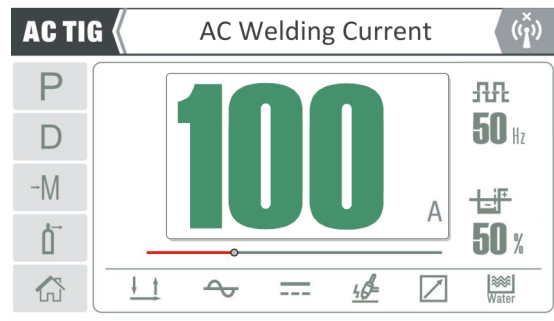

The welding Function Setting access icon is identified by the 'P' symbol and rotating the control dial clockwise or anti-clockwise will scroll you through all accessible options which are noted by being highlighted green, once the 'P' icon is highlighted, press the control dial button to enter the welding function settings page.

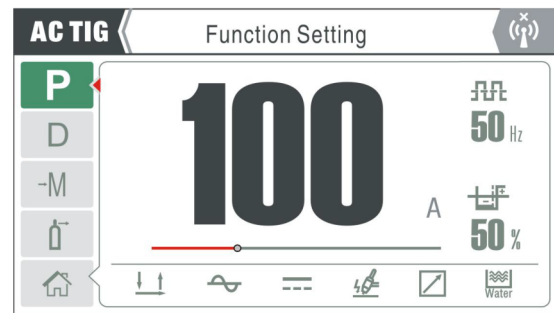

On entering the Functions Settings screen, you will note a row of function setting icons and the 'trigger' control icon will be automatically highlighted green.

Rotating the control dial clockwise will scroll you through the other available AC TIG function settings, rotating the dial anti-clockwise will then take you back through the settings until 'P' is highlighted in green again.

Rotate the dial until the trigger option is highlighted green and press the control dial button to enter trigger mode selection screen.

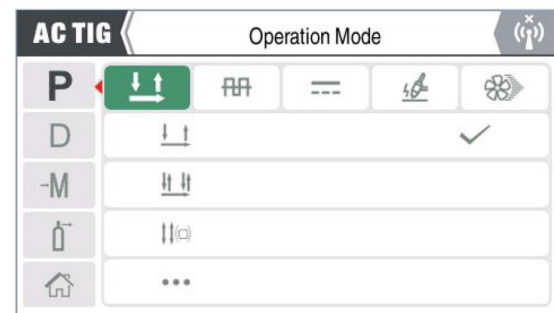

Once you have entered Trigger selection mode screen, you will see that the trigger (as shown right) is highlighted green on the 2T trigger mode, rotating the control dial clockwise or anticlockwise will scroll you through the trigger mode options. Once set on your required choice, pressing the control dial button will save your chosen setting and return you to the previous setting of highlighting the trigger icon green where you can then rotate the control dial to select the next function setting you wish to adjust.

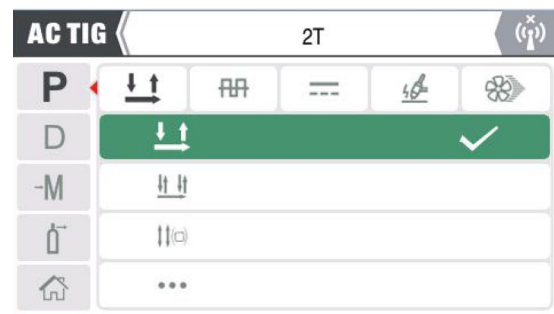

For further information on welding function choice, settings and description, please go to page 20.

NAVIGATING THE 'LCD' CONTROL PANEL

System Setting - Selection and Adjusting

As per previous pages, to access and adjust System Settings from the home screen, just navigate to the System Settings icon which will be highlighted green (as shown right). Then press the control dial button to enter this option screen.

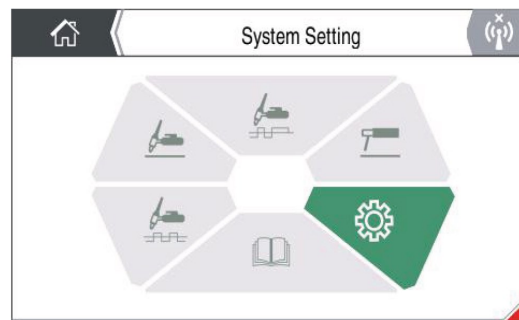

Settings Screen

Once entering the system settings screen, you will note a row of setting options as follows:

- User background Settings
- Language
- System Information
- Home

Rotating the control dial clockwise or anticlockwise will allow you to scroll through system icon options.

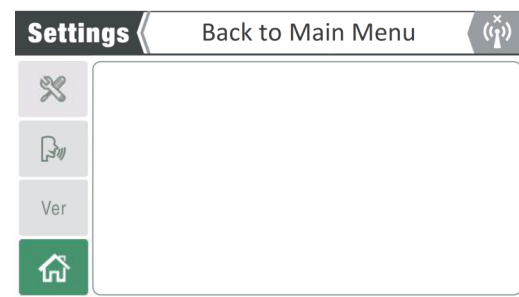

System Information

To enter the system information screen, rotate the control dial to select the 'Ver' icon (as shown right) and press control dial button to access the system information page which reveals the machine information, which is displayed in order from: Rated Current, Software Version No, LCD Version No and Machine Serial No.

Press the return button to go back to the previous screen.

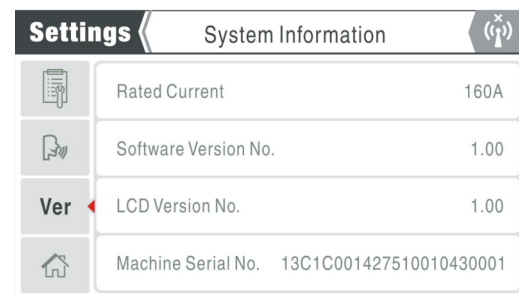

Language Selection

To enter the system information screen, rotate the control dial to select the language icon (as shown right) and press control dial button to access the language choice screen.

Rotating the control dial clockwise or anticlockwise will scroll you through the language choice options.

Once set on your required language choice, pressing the control dial button will save your chosen setting.

Press the return button to go back to the previous screen.



NAVIGATING THE 'LCD' CONTROL PANEL

System Setting - Selection and Adjusting

User Background Settings

As per previous page, to access and adjust user background settings from the home screen, navigate to the background settings icon which will be highlighted green (as shown right). Then press the control dial button to enter this option screen

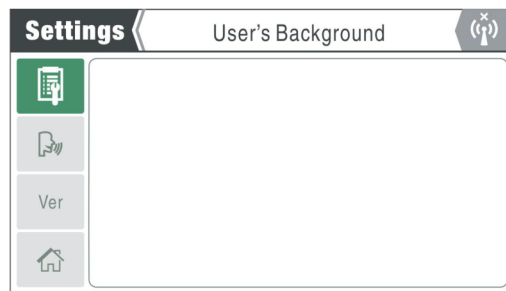

Settings Screen Options

Once entering the user background settings screen, you will note a row of setting options as follows:

- Overvoltage / Undervoltage Protection Switch (as shown below)
- Sleep Time Adjustment
- Remote Control Mode (Local/Remote)
- Wireless Remote Control Pairing
- Parameter Reset
- Factory Reset

Rotating the control dial clockwise or anticlockwise will allow you to scroll through system icon options.

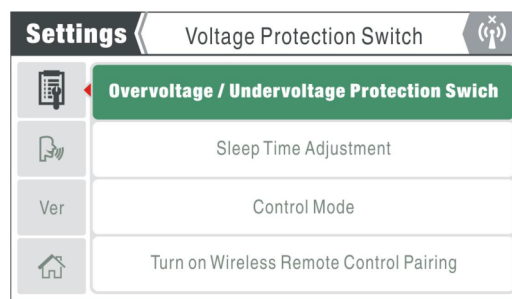

Overvoltage & Undervoltage Protection Switch

To enter the input voltage protection switch control function screen, rotate the control dial to select the said icon (as shown directly above) and press control dial button to access the control.

Here you can select either OFF or ON for input voltage protection by rotating the control dial and then pressing the control dial button to confirm your choice.

This option is factory set to ON, please speak with Jasic technical before interfering with this setting.

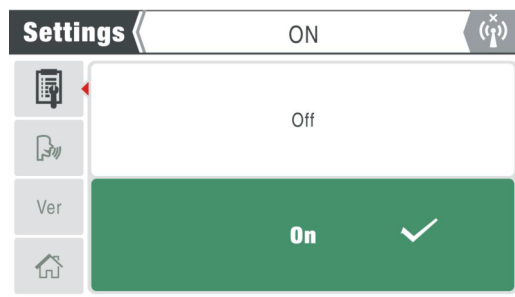
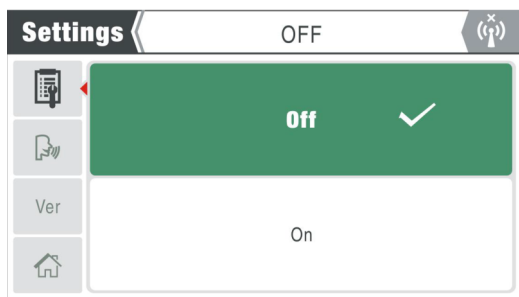

Pressing the control dial button will confirm and save your choice and return you to the previous screen otherwise press the return button to go back to the previous screen.

NAVIGATING THE 'LCD' CONTROL PANEL

System Setting - Selection and Adjusting

Sleep Time Adjustment Option

Standby time is a function that when there is no operator activity with the Jasic TIG machine, then after a pre-determined time (Factory time: 5 minutes) the machine will go into standby (sleep) mode.

To enter the standby sleep timer mode function screen, rotate the control dial to select the said icon (as shown directly below) and press control dial button to access the control.

Here you can select the standby sleep time by rotating the control dial which will scroll through the standby sleep time options of 0, 5, 10 and 15 minutes.

(The Factory default setting is 5 minutes and 0 means the standby time function is switched off).

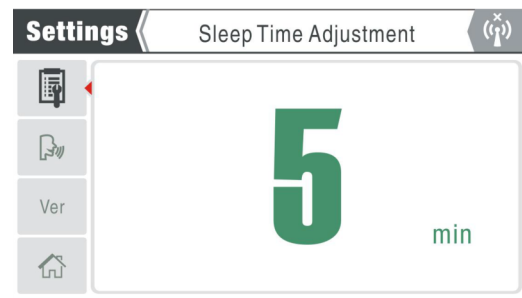
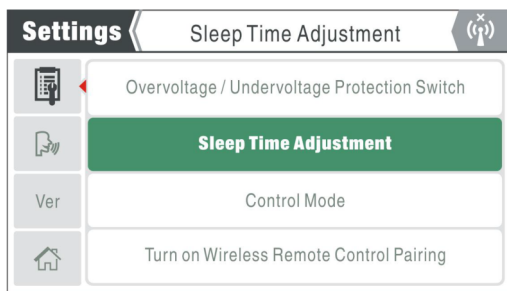

Pressing the control dial button will confirm and save your choice and return you to the previous screen.

The standby sleep time function is only available in TIG mode (if activated).

If the machine is not used within the preset period of time (5 minutes for example), the machine will then enter a standby state where the unit powers down and the screen will show just the Jasic logo only.

The machine will wake up immediately and the screen show the previous data when either the torch trigger, remote device or if one of the control panel buttons are pressed.

NAVIGATING THE 'LCD' CONTROL PANEL

System Setting - Selection and Adjusting

Parameter and Factory reset function

Accessing the parameter and factory reset function, is straight forward, press the 'home' button and from the home screen menu, navigate and enter into 'system settings' and then enter 'user background' settings and then scroll down to either the parameter reset or the factory reset function which the later is shown and highlighted green to the right.

The operational function process is the same for parameter reset as it is for factory reset.

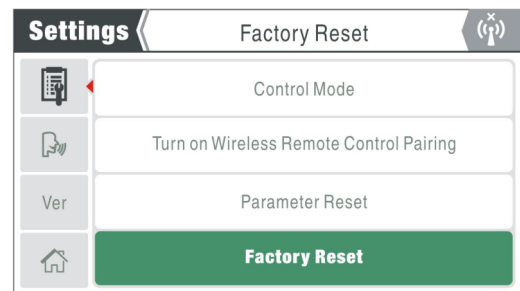

Factory reset function

1. Select the Factory Reset option by pressing the control dial button
2. Rotate the control dial to select and confirm your required option of either "Sure" or "Cancel" as shown below.

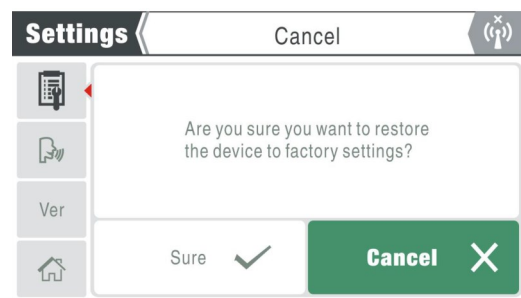
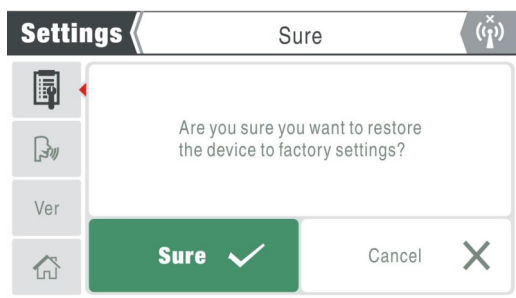

3. Once you have pressed the control dial on the highlighted green "sure" tab a new pop up green box will be displayed indicating "Waiting for factory reset", after approximately 10 seconds the system will complete the machine has been reset to factory settings and the screen will return to the home page.

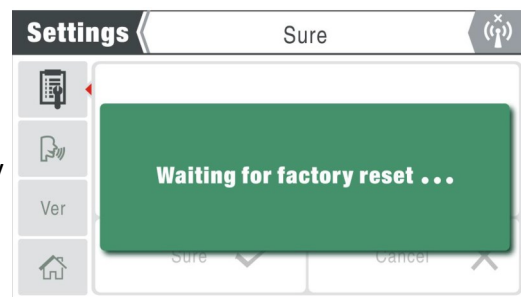

Parameter reset function

1. Select the Parameter Reset option by pressing the control dial button
2. Rotate the control dial to select the required option of either "Sure" or "Cancel".
3. Once you have pressed the control dial on the highlighted green "sure" tab a new pop up green box will be displayed indicating "Waiting for parameter reset", after approximately 10 seconds the system will complete the process and any saved parameter settings have been reset and the screen will go back to the previous menu rather than returning to the home page.

CONTROL PANEL - FUNCTIONS

System Setting - Selection and Adjusting

Restored Parameter Settings

Welding Parameter	Unit	MMA	DC TIG	DC Pulse TIG	AC TIG	AC Pulse TIG	Mixed TIG
Pre-flow time	Seconds	-	0.5	0.5	0.5	0.5	0.5
Initial current	Amps	-	20	20	20	20	20
Up-slope time	Seconds	-	0.5	0.5	0.5	0.5	0.5
Peak current	Amps	-	100	100	100	100	100
Base current	Amps	-	-	50	-	50	-
Down-slope time	Amps	-	0.5	0.5	0.5	0.5	0.5
Final current	Amps	-	20	20	20	20	20
Post-flow time	Seconds	-	2	2	2	2	2
Spot welding time	Seconds	-	1	-	1	-	-
Pulse frequency	Hz	-	-	50	-	50	-
Pulse duty cycle	%	-	-	50	-	50	-
Welding current	Amps	100	-	-	-	-	-
Hot start current	Amps	30	-	-	-	-	-
Arc-force current	Amps	30	-	-	-	-	-
AC Frequency	Hz	-	-	-	20	20	20
Ac Balance	%	-	-	-	20	20	20
Mixed Frequency	Hz	-	-	-	-	-	2
Mixed Duty Cycle	%	-	-	-	-	-	20

The factory parameter settings for the ET-200PACDC machine are as shown in the table below.

VRD Function

 Voltage Reduction Device (VRD) is a hazard reducing circuitry inbuilt into welding power sources which is used in the MMA/Stick welding process which reduces the open circuit voltage (OCV) when the voltage output of the machine is ON but not welding to a safe voltage (normally under 20V). VRD has no effect on arc starting.

The factory setting for VRD is ON and The VRD symbol will be on show when the machine is in MMA mode and the output voltage is limited to 11.5V when the machine is idle (as shown right).

Please Note:

- The VRD icon will go off when the welding arc is established.
- VRD can be disabled although this requires a technician to carry out this task, please contact your supplier for further details.

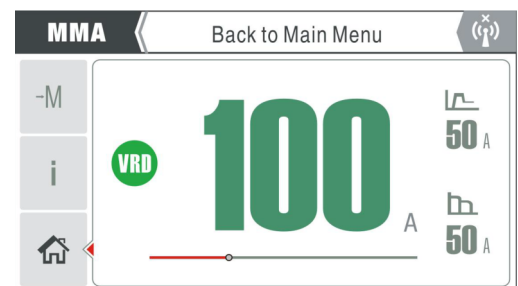

CONTROL PANEL - FUNCTIONS

System Setting - Selection and Adjusting

User Manual

Accessing the User Manual is straight forward, press the 'home' button and from this home screen menu, navigate to the notebook icon and press the control dial button to enter the user guide (as shown right).

From here you can navigate through various sections and pages of the operating manual.

Please Note: For the latest and more in-depth version of the Jasic ET-200PACDC operating manual, please visit www.jasic.co.uk and look the product page up and then click on documents.

When In the User Manual screen, you can rotate the control dial to select the section tabs on the left of the screen which are:

- Operation
- Components (Spare Parts)
- Maintenance

When you select for example select and enter the operation tab, you will then open up the operation page which also offers a secondary top row of page tabs with further user operational data.

Rotating the control dial will scroll you through these pages which will be highlighted green.

- The Operation tab also includes further information on Panel Operation, Front Panel Connection, Rear Panel Operation and Welding Guide.
- The Components (Spare Parts) tab also includes further information on Welding Torch, Consumables, Earth Cable and other parts.
- The Maintenance tab also includes further information on Alarms and Solutions, Repair Parts and Troubleshooting.

When you access or open pages of the operating manual the page maybe larger that the screen, if you then press the control dial button you will enlarge the page, image or chart and will be able to scroll through the page data by rotating the control dial, pressing the control dial button will return you to the previous page.

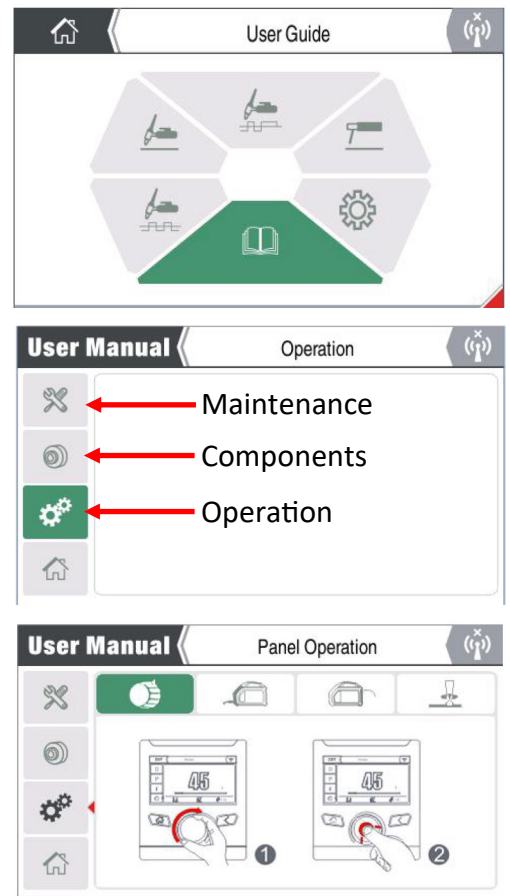

CONTROL PANEL - FUNCTIONS

System Setting - Selection and Adjusting

Alarm function

The Evo range of machines have inbuilt protection devices and in the unfortunate case of a malfunction, an error code is indicated along with the corresponding error description appears on the LCD display as the example right shows.

As long as an error code is shown, welding operation is generally not possible.

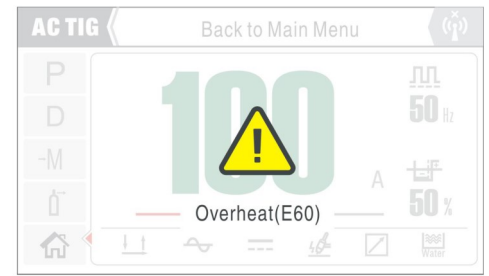

There are seven alarm conditions that the machine can experience as follows:

Overcurrent Protection (E10), Undervoltage Protection (E31), Overvoltage Protection (E32), Data error alarm (E55), Overheat Protection (E60), Overheat protection (E61), Water Cooler Alarm (E71).

See from page 77 for further information on error codes and troubleshooting them.

Screen (Saver) Protection Mode

When the machine is switched on but has not been operated or used for a set period of time (standby time, see page 28 for further details), the unit will enter into standby (idle) mode and the machine will enter sleep mode although the screen display will only show the protection image which is the Jasic logo (as shown right).





The machine will wake up immediately and the screen will show the previous data if either the torch trigger, remote device or one of the control panel buttons are pressed.

Water cooler control

Depending on whether you are using an air or water cooled TIG torch will depend on if the water cooled control mode is set to enabled or disabled.

When in any TIG welding mode, either an icon indicator will show either an air cooled icon or the water cooled icon option, the icon that shows indicates that is the mode selected.

- If the  indicator is showing, this indicates that the machine is setup as air-cooled.
- If the  indicator is showing, this indicates that the machine is setup as water-cooled.

With a water cooler fitted and the control enabled when the output is activated and welding starts the water cooler will start and then circulate the coolant around the system, when welding stops and there is no current output, the water cooler will continue to circulate coolant for 5 minutes before stopping.

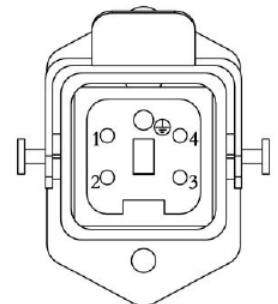

Always enable water-cooled mode when using a water-cooled TIG welding torch.

The 5 pin cooler control socket is mounted on the rear panel of the machine.

- Pins 1 and 2 is the power output connections for the water cooler.
- Pins 3 and 4 is the fault signal input connections (no coolant flow signal).

See pages 85 for further details on the water cooler.

Please Note:

The EVO ET-200PACDC can only use the originally designed LC30 Jasic water cooler. Do not use water coolers purchased from other manufacturers.

REMOTE CONTROL SOCKET

The Jasic TIG ET-200PACDC is fitted with 9 pin remote control socket located on the front panel which is used to connect various remote control devices, for example: a TIG torch with trigger switch, a TIG torch with mounted switch and current adjustment dial, the Jasic FRC-01 footpedal or other similar devices including MMA remote control devices.

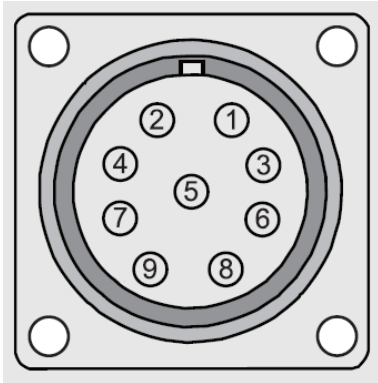

When fitting the 9 pin remote plug, ensure you align the keyway when inserting the plug, then rotate the threaded collar fully clockwise until finger tight.

The 9 pin plug and clamp part number is: JSG-PLUG-9PIN

9 Pin Remote socket configuration			
Pin	Description	Signal	Description MMA
1	Potentiometer (min)	VCC	Power supply
2	Potentiometer wiper	ASI	Analog signal
3	Potentiometer (max)	A_GND	Analog signal GND
4	- (negative)	DIG_SI -	Digital signal -
5	+ (positive)	DIG_SI +	Digital signal +
6	Parameter selection	TYPE1	Foot pedal controller recognition /Digital signal Selection
7	TYPE	TYPE	Analog signal recognition (Connected to GND)
8	Torch switch	TORSWI	Torch switch signal
9	Torch switch/ground	GND	GND

Remote device activation



As with the previous page, to activate remote, press the remote button and the remote LED will illuminate (as shown left), this indicates that the machine is ready to be used with a remote control device.

Pressing the remote button again will turn off remote control.

Remote Control Device Wiring

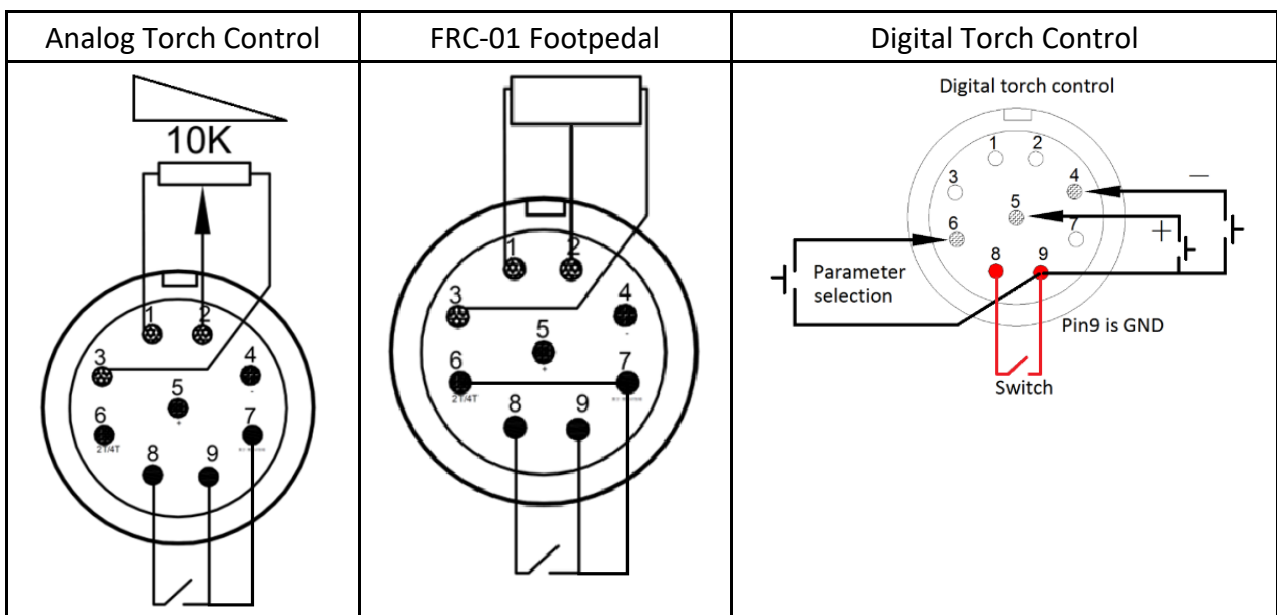

WIRED REMOTE CONTROL FUNCTION

Remote Control Option

The EVO machine range of machines allow the user to use either wired or wireless technology for remote control purposes that offers the user to use wired or wireless hand or foot controls when using the machine in MMA or TIG AC/DC welding modes.

The remote selection control allows the user to select current control from either the front panel or to be controlled remotely either via the 9 pin control socket or via the optional wireless control for MMA and TIG remote control devices.

To enter the remote control mode function screen, rotate the control dial to select the control mode icon (as shown right) and press control dial button to access this function.

Here you can select the remote control ON or OFF by rotating the control dial which will scroll through either ON/OFF options.

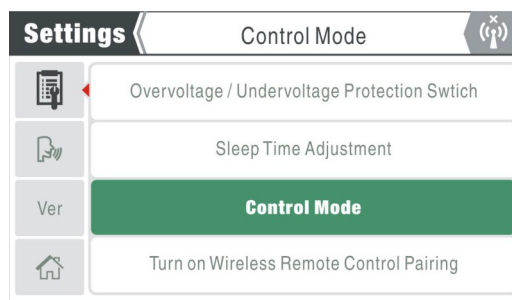

Pressing the control dial button will confirm and save your choice and return you to the previous screen.

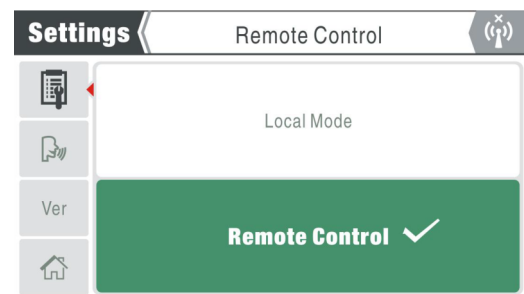
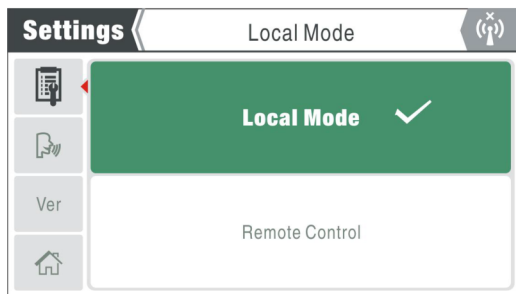

WIRELESS REMOTE CONTROL FUNCTION

Wireless Remote Control Option

As stated above the EVO range can also allow the user to use wireless technology for remote control purposes that offers the user to use wireless hand or foot controls when using the machine in MMA or TIG AC/DC welding modes.

Wireless Remote Control Pairing Procedure

To use a remote control wireless device, first you need to ensure that you have a fitted the wireless receiver to your machine, see page 16 of this operating manual for further detail.

WIRELESS REMOTE CONTROL FUNCTION

Wireless Remote Control Pairing Procedure:

As per previous pages, to access wireless pairing from the home screen, navigate and enter into System Settings and then enter User Background settings and then scroll down to Turn on Wireless Pairing which will be highlighted green (as shown right).

Then press the control dial button to enter the wireless pairing option screen.

- At this point, ensure your remote wireless device is charged and turned ON
- On accessing the pairing screen, the machine will automatically start to scan for a wireless device
- This is confirmed by the screen showing "Pairing, please wait"
- Ensure that your remote device is in pairing mode (see remote control instructions supplied with your device)

Once wireless pairing is successful the screen will display connection confirmation by stating "Pairing successful !" and the wireless connection indicator icon display the wireless icon without a 'x' above it.

You will also note that the highlighted green bar has changed from Turn 'on' to Turn 'off' wireless.

Once this task is completed either press the 'back' button or press the 'home' button to continue to use the machine.

Disconnecting the wireless connection:

After a wireless remote control device was successfully paired, disconnecting is similar to above.

There is 2 ways to disconnect the wireless device:

1. Press and hold the remote control device pairing key or
2. Access the machines wireless remote control pairing option screen and press the control dial button on the highlighted green "turn off wireless remote control pairing" tab.

Once the wireless device is disconnected the screen will show the wireless 'disconnected' icon and the highlighted green tab will change to turn 'on' (as shown right).

Once this task is completed either press the 'back' button or press the 'home' button to continue to use the machine.

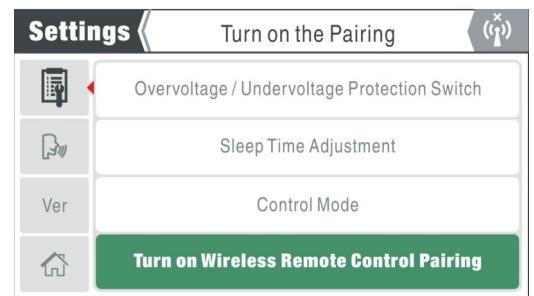
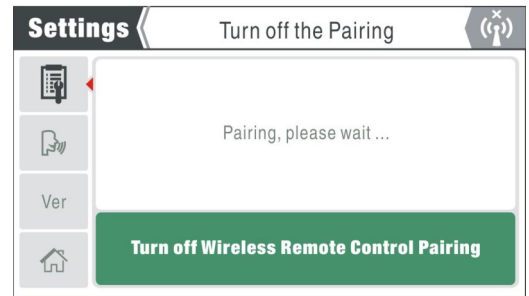
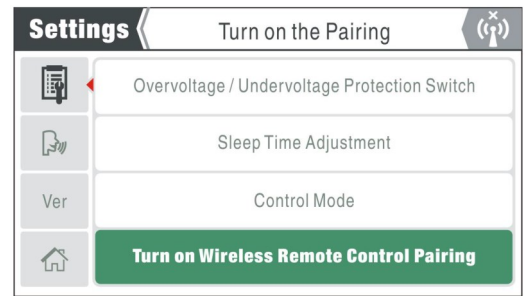

MMA SETUP

Output connections

Electrode polarity is generally determined by the type of welding rod being used although in general when using manual arc welding electrodes the electrode holder is connected to the positive terminal and the work return to the negative terminal.

Generally, there are two connection methods of DC welder: DCEN and DCEP connection.

DCEN: The welding electrode holder is connected to the negative polarity, and the workpiece is connected to the positive polarity.

DCEP: The electrode holder is connected to the positive polarity, and the workpiece is connected to the negative polarity.

The operator can choose DCEN based on the base metal and welding electrode. Generally speaking, DCEP is recommended for basic electrodes (i.e. electrode connected to the positive polarity).

Always consult the electrode manufacturer's data sheet if you have any doubts.

MMA welding

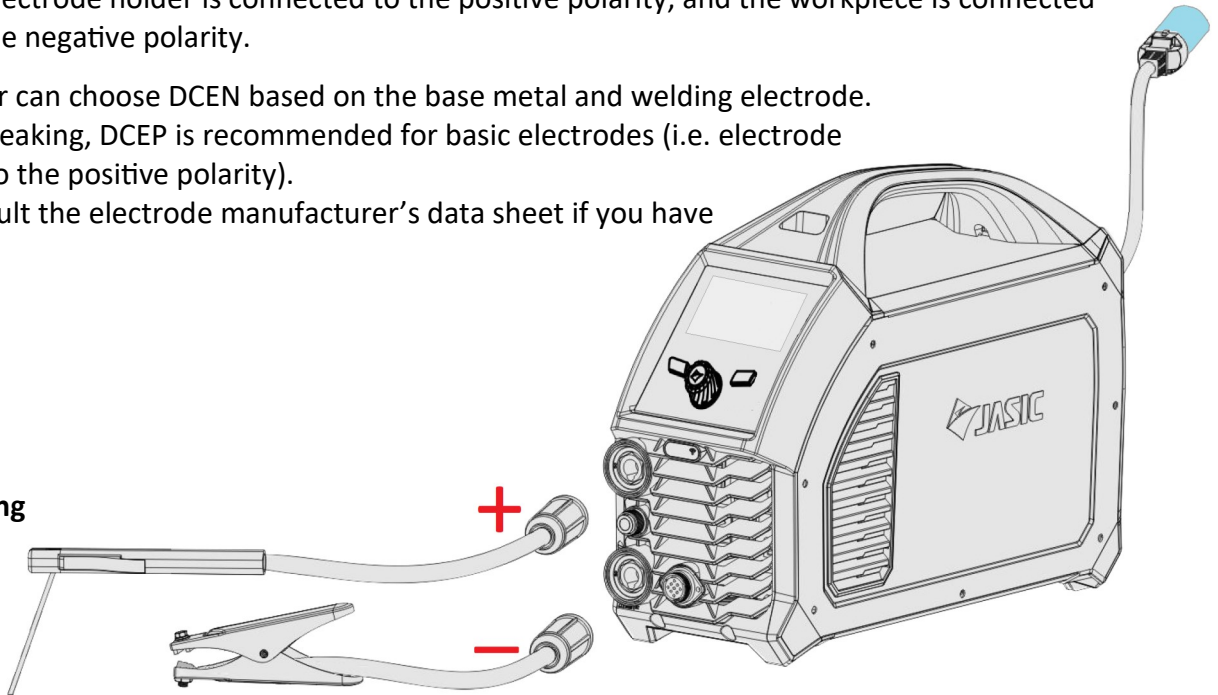

1. When connecting welding cables, ensure that the machine's ON/OFF mains switch is turned off and never connect the machine to the mains supply with the panels removed.
2. Insert the cable plug with electrode holder into the "+" socket on the front panel of the welding machine and tighten it clockwise. *
3. Insert the cable plug of the work return lead into the "-" socket on the front panel of the welding machine and tighten it clockwise. *

If you want to use long secondary cables (Electrode holder cable and/or earth cable), you must ensure that the cross-sectional area of the cable is increased appropriately in order to reduce the voltage drop due to the cable length.

* Always check the specifications of the welding rod being used to ensure correct polarity is used.

Please Note:

Check these power connections daily to ensure they have not become loose otherwise arcing may occur when used under load.

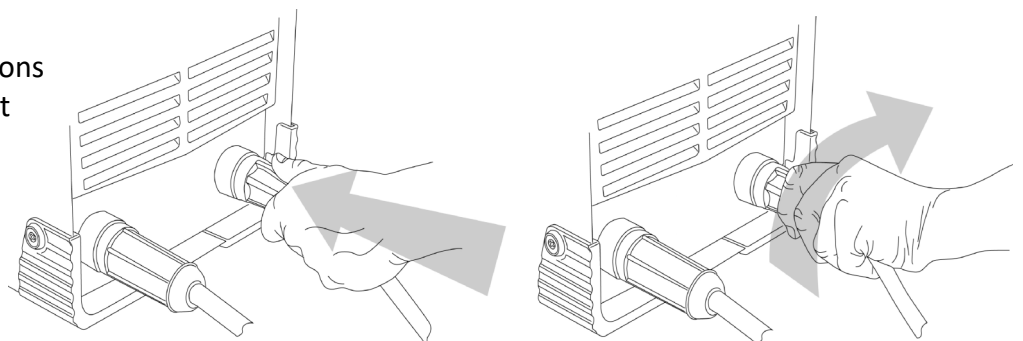

Generic library picture

OPERATION - MMA



Before starting any welding activity ensure that you have suitable eye protection and protective clothing. Also take the necessary steps to protect any persons within the welding area.

MMA welding

MMA (Manual Metal Arc), SMAW (Shielded Metal Arc Welding) or just Stick Welding. Stick welding is an arc welding process which melts and joins metals by heating them with an arc between a covered metal electrode and the work.

Shielding is obtained from the electrode outer coating, often called flux. Filler metal is primarily obtained from the electrode core.

The electrodes outer coating called flux assists in creating the arc and provides a shielding gas and on cooling forms a slag covering to protect the weld from contamination.

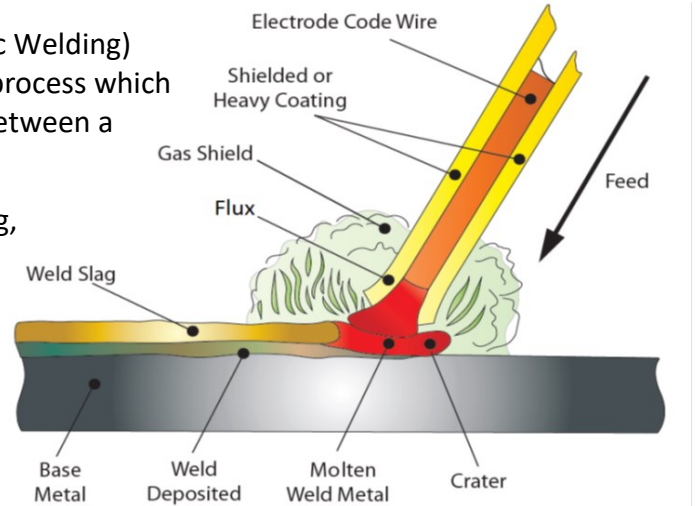

When the electrode is moved along the work piece at the correct speed the metal core deposits a uniformed layer called the weld bead.

After connecting the welding leads as detailed above, plug your machine into the mains supply and turn 'ON' the machine, the power switch is located at the rear panel of the machine, place it to the "ON" position, the panel indicator will then light up, the fan may start to rotate as the welding machine powers up and the control panel will also light up to indicate that the machine is ready to use as shown below.

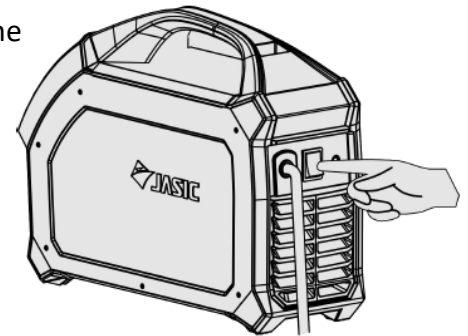

Caution, there is voltage output at both output terminals.

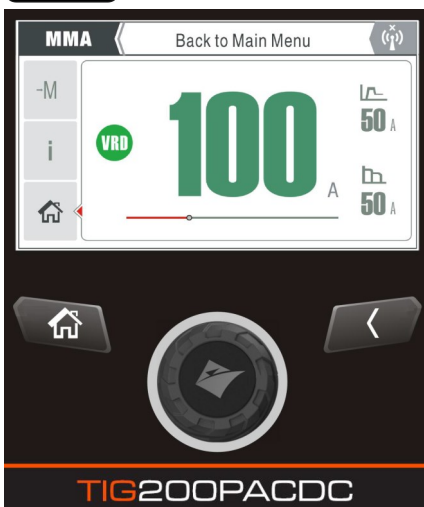

PLEASE NOTE:

Some welding models are equipped with the smart fan function. When the power supply is turned on after a period before welding starts, the fan will automatically stop running. The fan will then run automatically when welding begins.

Now you can connect the welding leads as shown in the image below, ensure you check that you have the electrode polarity correct to match the welding rod being used.

In the image left, you will note that MMA has been selected and that MMA current control is selected and highlighted in green and as shown preset to 100 amps which can be

adjusted by rotating the control dial clockwise or anti-clockwise to increase or decrease the welding current.

In MMA mode you can see if a wireless device has been connected but you cannot not see if the remote control option is turned on or off.

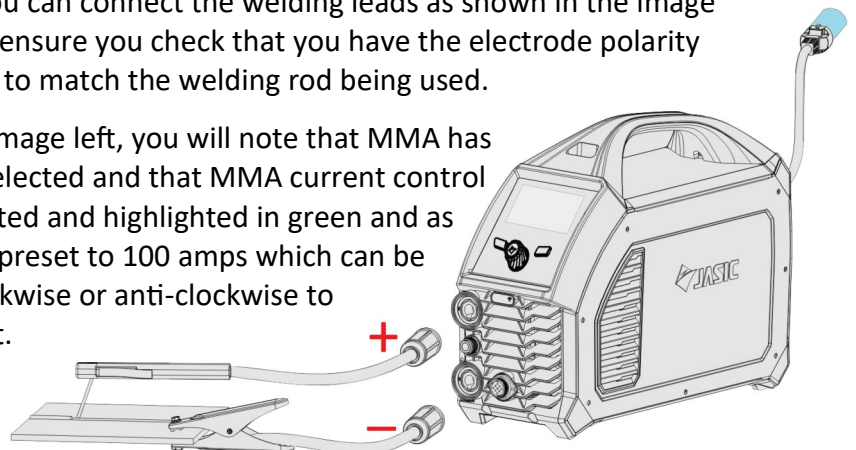

OPERATION - MMA



Before starting any welding activity ensure that you have suitable eye protection and protective clothing as, welding rays, spatter, smoke and high temperatures produced in the process may cause injury to personnel.

Also take the necessary steps to protect any persons within the welding area that may cause injury to.

MMA welding

From the home screen, rotate the control dial and select MMA welding mode by pressing the control dial button until the MMA symbol is illuminated green as shown in the image right.

When entering MMA mode you can easily access and adjust welding current straight away, hot start current and arc force parameters are also accessible and easily as described below.

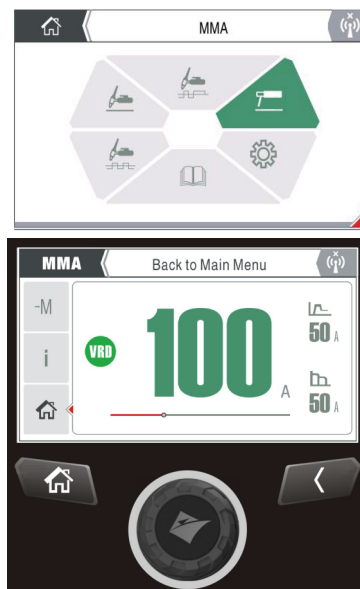

100 A MMA current adjustment can now be carried out via the panel control dial and this can be achieved by rotating the control dial clockwise or anti-clockwise to increase or decrease the welding current, you will note that the progress bar adjusts proportionally with the current preset value.

Please Note: Welding current adjustment can be carried out during welding.

To access the further MMA welding parameters, press the control dial button which now highlights the preset welding current area in a raised rectangle (as detailed on Page 25) you can now rotate the control dial which as you scroll through will highlight (in a raised box or in green) further parameters and options.

50 A To select MMA ignition current (start current), press the control dial button on the icon shown left and the ignition (start) current icon illuminates green, you can now rotate the control dial clockwise or anti-clockwise until the desired start current is displayed. The start current range is 0 ~ 80 amps.

50 A To select MMA arc force, press the control dial button on the icon shown left and the arc force current icon illuminates green, you can now rotate the control dial clockwise or anti-clockwise until the desired arc force is displayed. The arc force current range is 0 ~ 40 amps.

If the secondary welding cables (welding cable and earth cable) need to be very long, considering welding cable with larger cross-section to reduce the voltage drop.

VRD indicator



In MMA mode, the VRD LED will be lit to indicate that VRD is active and the machine output voltage is 11.5V.

The table right offers a guide to set up for various welding electrode diameters sizes versus recommended current ranges.

The operator can set their own parameters based on the type and diameter of welding electrode and their own process requirements.

PLEASE NOTE:

The operator should set the parameters that meet the welding requirements. If the selections are incorrect this may lead to problems such as an unstable arc, spatter or sticking of the welding electrode to the work

Electrode Size (mm)	Recommended Welding Current (A)
1.0	20 ~ 60
1.6	44 ~ 84
2.0	60 ~ 100
2.5	80 ~ 120
3.2	108 ~ 148
4.0	140 ~ 180
5.0	160 ~ 250

OPERATION - MMA



Before starting any welding activity ensure that you have suitable eye protection and protective clothing as, welding rays, spatter, smoke and high temperatures produced in the process may cause injury to personnel.

Also take the necessary steps to protect any persons within the welding area that may cause injury.

MMA welding

Arc force:

Arc force prevents the electrode sticking when welding. Arc force provides a temporary increase in current when the arc is too short and helps maintain consistent excellent arc performance on a wide range of electrodes. The Arc force value should be determined according to welding electrode diameter, current setting, and process requirements. High arc force settings lead to a crisper, higher penetration arc but with some spatter. Lower arc force settings provide a smooth arc with lower spatter and a good weld seam formation, but sometimes the arc is soft or the welding electrode can stick.

Hot start current:

The hot start current is an increase in welding current at the start of the weld to give excellent arc ignition and to avoid the electrode sticking. It also can reduce weld defects at the start of the weld.

The magnitude of hot start current is generally determined based on the type, specification, and welding current of welding electrode.

During DC welding the heat on the positive and negative electrodes of the welding arc is different. When welding using DC power supply, there are DCEN (DC electrode negative) and DCEP (DC electrode positive) connections. The DCEN connection refers to the welding electrode connected to the negative electrode of the power supply and the work piece connected to the positive electrode of the power supply.

In this mode the work piece receives more heat, resulting in high temperature, deep molten pool, easy to weld through, suitable for welding thick parts. The DCEP connection refers to the welding electrode connected to the positive power supply with the work piece connected to the negative power supply.

In this mode the work piece receives less heat, resulting in low temperature, shallow pool, and difficulty in welding through. This is suitable for welding thin parts.

During welding:

PLEASE NOTE: This unit has anti-stick function by default. In the welding process, if a short circuit occurs on the welding output for 2 seconds, the machine will automatically enter anti-stick mode. This means the welding current will automatically drop to 20A to allow the short circuit to be cleared. When the short circuit is cleared the welding current will automatically return to the set current.

Turn off the power supply after welding

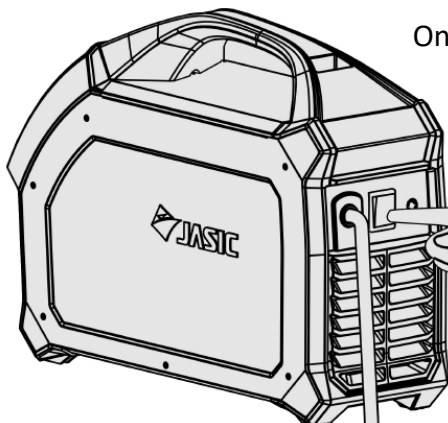

On completion of any welding operating, the machine should be powered down. The power switch is located on the rear panel of the machine and should be set to the "off" position.

It maybe noted that for a short period of time that the machine fan continues to run, this is quite normal and after a short time delay, the control panel lights indicator will turn off and the fan will stop indicating that the welder has now fully powered down.

GUIDE TO MMA WELDING



Before starting any welding activity ensure that you have suitable eye protection and protective clothing.

Also take the necessary steps to protect any persons within the welding area.

MMA process tips and guides

Typical welder set up

1. Electrode holder
2. Work return clamp
3. Work piece
4. Weld material covered by electrode flux or slag
5. Electrode
6. Distance from work to electrode (arc Length)

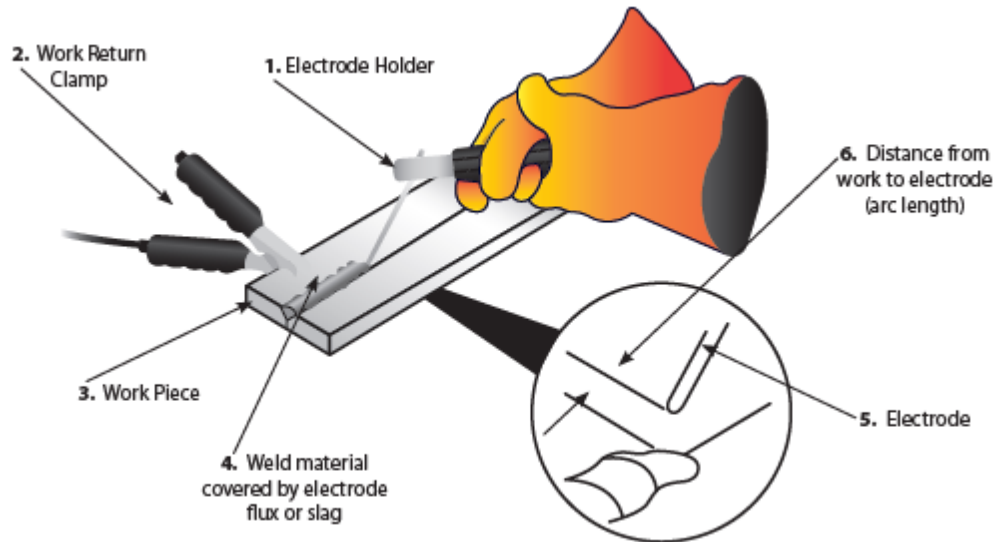

Welding current will flow in the circuit as soon as the electrode contacts the work piece. The welder should always ensure a good connection of the work clamp. The nearer the clamp is placed to the welding area the better.

When the arc is struck the distance between the end of the electrode and the work will determine the arc voltage and also affect the weld characteristic. As a guide the arc length for electrodes up to 3.2mm diameter should be around 1.6mm and over 3.2mm around 3mm.

Upon completion of the weld the welding flux or slag will need to be removed usually with a chipping hammer and wire brush.

Joint form in MMA

In MMA welding, the common basic joint forms: butt joint, corner joint, lap joint & T joint.

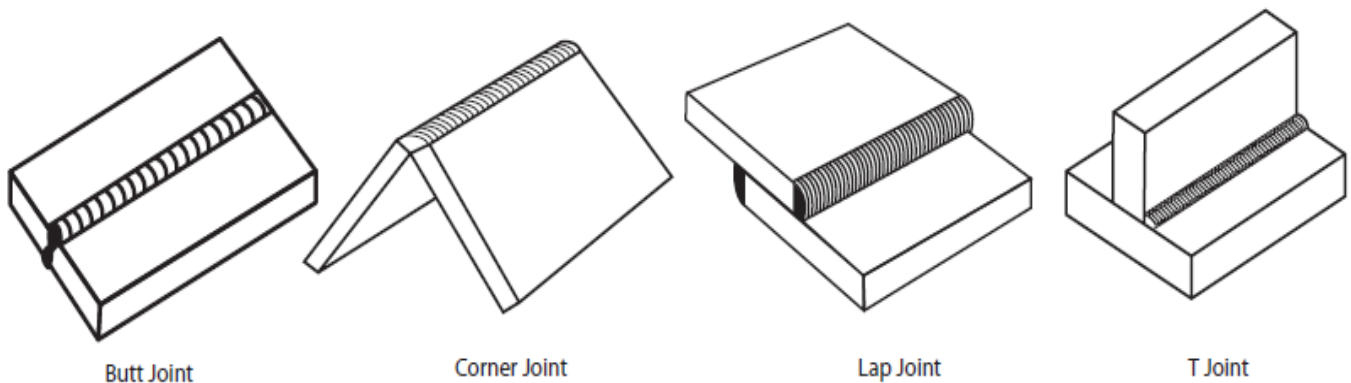

GUIDE TO MMA WELDING



Before starting any welding activity ensure that you have suitable eye protection and protective clothing.

Also take the necessary steps to protect any persons within the welding area.

MMA arc striking

Tap Technique - Lift the electrode upright and bring it down to strike the work piece. After forming a short circuit, quickly lift up about 2~4mm and arc will be ignited. This method is difficult to master.

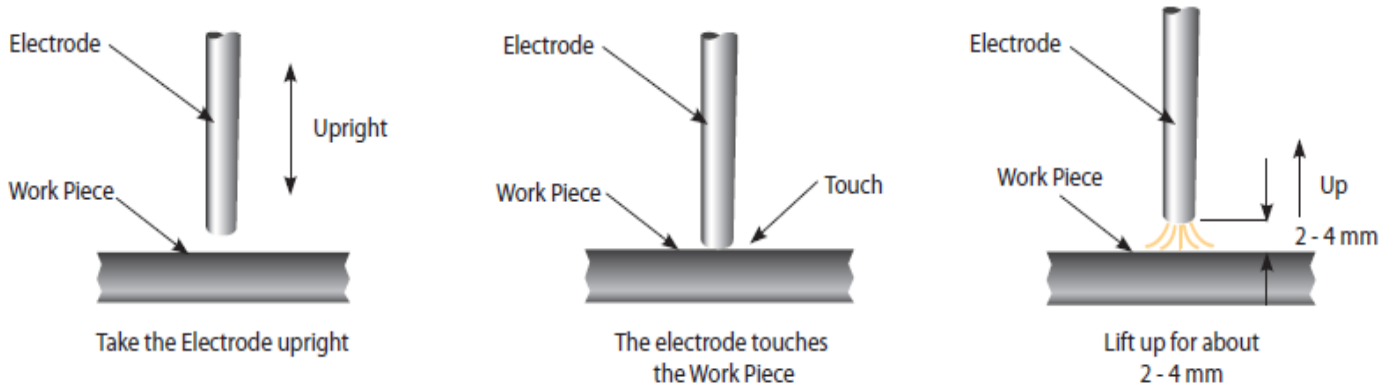

Scratch technique - Drag the electrode and scratch the work piece as if striking a match. Scratching the electrode may cause the arc to burn along the scratch path, so care should be taken to scratch in the weld zone. When the arc is struck adopt the correct welding position.

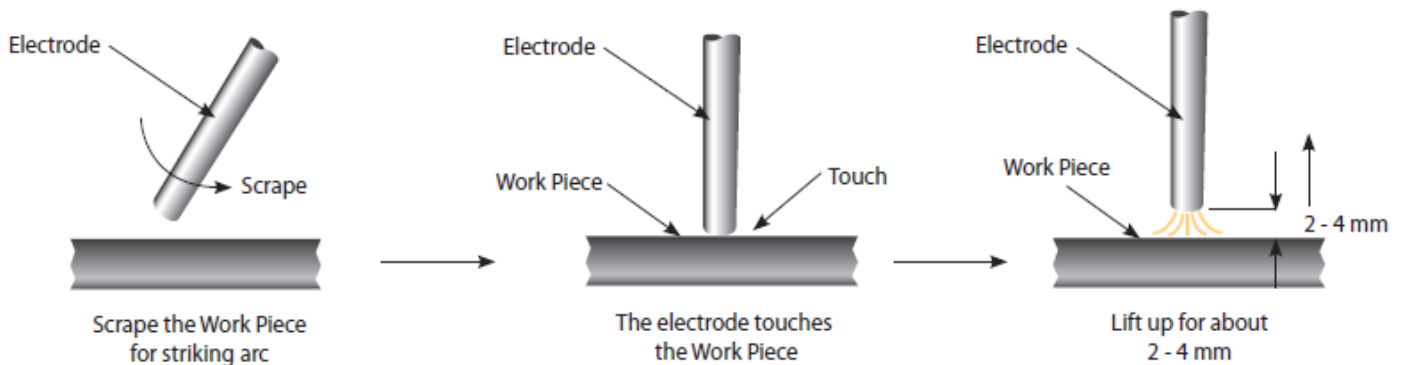

Electrode positioning

Horizontal or flat position

The electrode should be positioned at right angles to the plate and inclined in the direction of travel at around 10°-30°.

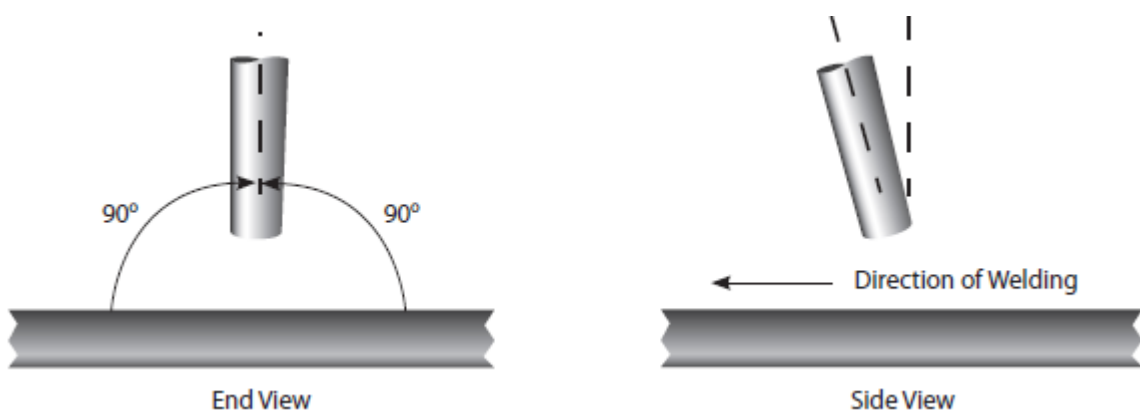

GUIDE TO MMA WELDING



Before starting any welding activity ensure that you have suitable eye protection and protective clothing.

Also take the necessary steps to protect any persons within the welding area.

Fillet welding

The electrode should be positioned to split the angle i.e. 45° . Again the electrode should be inclined in the direction of travel at around 10° - 30° .

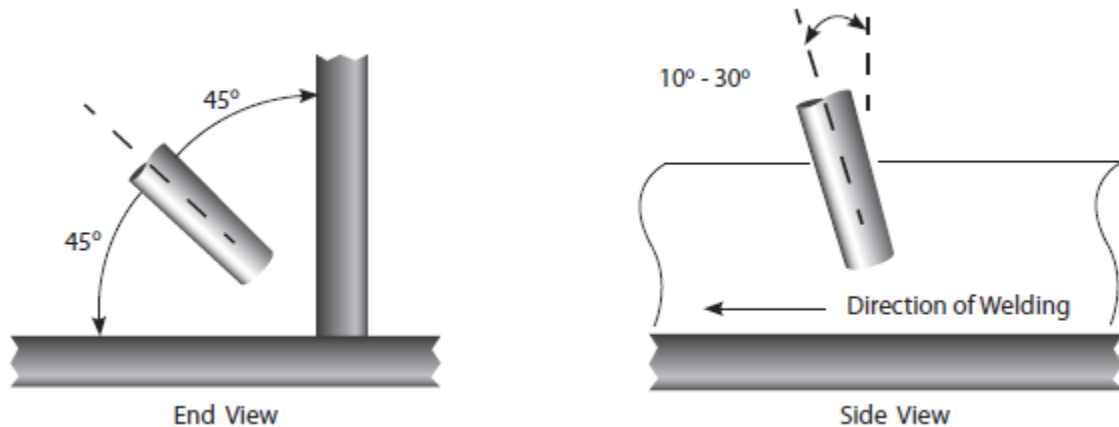

Manipulation of electrode

In MMA welding there are three motions used at the end of electrode:

1. The electrode feeding to the molten pool along axes
2. The electrode swing right and left
3. The electrode moving in the weld direction

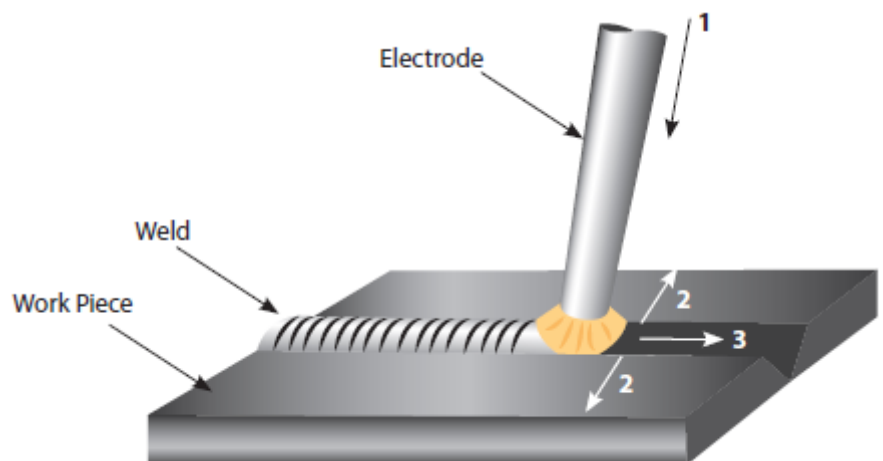

The operator can choose the manipulation of electrode based on welding joint, welding position, electrode spec, welding current and operation skill etc.

Weld characteristics

A good weld bead should exhibit the following characteristics:

1. Uniform weld bead
2. Good penetration into the base material
3. No overlap
4. Fine spatter level

A poor weld bead should exhibit the following characteristics:

1. Uneven and erratic bead
2. Poor penetration into the base material
3. Bad overlap
4. Excessive spatter levels
5. Weld crater

GUIDE TO MMA WELDING



Before starting any welding activity ensure that you have suitable eye protection and protective clothing. Also take the necessary steps to protect any persons within the welding area.

Notes for the welding beginner

This section is designed to give the beginner who has not yet done any welding some information to get them going. The simplest way to start is to practice by running weld beads on a piece of scrap plate. Start by using mild steel (paint free) plate of 6.0mm thick and using 3.2mm electrodes.

Clean any grease, oil and loose scale from the plate and fix firmly to your work bench so that welding can be carried out. Make sure that the work return clamp is secure and making good electrical contact with the mild steel plate, either directly or through the work table. For best results always clamp the work lead directly to the material being welded, otherwise a poor electrical circuit may create itself.

Welding position

When welding, ensure you place yourself in a comfortable position for welding and your welding application before you begin to weld. This may be sitting at a suitable height which often is the best way to weld ensuring you're relaxed and not tense. A relaxed posture will ensure the welding task becomes much easier.

Please ensure you always wear suitable PPE and use suitable fume extraction when welding.

Place the work so that the direction of welding is across, rather than to or from your body.

The electrode holder lead should always be clear of any obstruction so that you can move your arm freely along as the electrode burns down. Some welders prefer to have the welding lead over their shoulder, this allows greater freedom of movement and can reduce the weight from your hand.

Always inspect your welding equipment, welding cables and electrode holder before each use to ensure it's not faulty or worn as you may be at risk of an electric shock.

MMA process features and benefits

The versatility of the process and the skill level required to learn, basic simplicity of the equipment make the MMA process one of the most common used throughout the world.

The MMA process can be used to weld a wide variety of materials and is normally used in the horizontal position but can be used in vertical or overhead with the correct selection of electrode and current. In addition, it can be used to weld at long distances from the power source subject to the correct cable sizing. The self-shielding effect of the electrode coating makes the process suitable for welding in external environments. It is the dominant process used in maintenance and repair industries and is used extensively in structural and fabrication work.

The process is well able to cope with less than ideal material conditions such as dirty or rusty material. Disadvantages of the process are the short welds, slag removal and stop starts which lead to poor weld efficiency which is in the region of 25%. The weld quality is also highly dependent on the skill of the operator and many welding problems can exist.

MMA WELDING TROUBLESHOOTING



Before starting any welding activity ensure that you have suitable eye protection and protective clothing.

Also take the necessary steps to protect any persons within the welding area.

Arc welding defects and prevention methods

<u>Defect</u>	<u>Possible cause</u>	<u>Action</u>
Excessive spatter (beads of metal scattered around the weld area)	Amperage too high for the selected electrode	Reduce amperage or utilise larger diameter electrode
	Voltage too high or arc length too long	Reduce arc length or voltage
Uneven and erratic weld bead and direction	Weld bead is inconsistent and misses joint due to operator	Operator training required
Lack of penetration – The weld bead fails to create complete fusion between material to be welded, often surface appears okay but weld depth is shallow	Poor joint preparation	Joint design must allow for full access to the root of the weld
	Insufficient heat input	Material too thick Increase the amperage or increase the electrode size and amperage
	Poor weld technique	Reduce travel speed Ensure the arc is on the leading edge of the weld puddle
Porosity – Small holes or cavities on the surface or within the weld material	Work piece dirty	Remove all contaminant from the material i.e. oil, grease, rust, moisture prior to welding
	Electrode is damp	Replace or dry the electrode
	Arc length is excessive	Reduce the arc length
Excessive penetration – The weld metal is below the surface level of the material and hangs below	Heat input too high	Reduce the amperage or use a smaller electrode and lower amperage
	Poor weld technique	Use correct welding travel speed
Burning through – Holes within the material where no weld exists	Heat input too high	Use lower amperage or smaller electrode Use correct welding travel speed
Poor fusion – Failing of weld material to fuse either with the material to be welded or previous weld beads	Insufficient heat level	Increase the amperage or increase the electrode size and amperage
	Poor welding technique	Joint design must allow for full access to the root of the weld Alter welding technique to ensure penetration such as weaving, arc positioning or stringer bead technique
	Work piece dirty	Remove all contaminant from the material i.e. oil, grease, rust, moisture prior to welding

TIG SETUP



Before starting any welding activity ensure that you have suitable eye protection and protective clothing. Also take the necessary steps to protect any persons within the welding area.

TIG welding mode

Terms used: TIG – Tungsten Inert Gas, GTAW – Gas Tungsten Arc Welding.

TIG welding is an arc welding process that uses a non-consumable tungsten electrode to produce the heat for welding.

The weld area is protected from atmospheric contamination by a shielding gas (usually an inert gas such as argon or helium) and a filler rod matching the base material is normally used, though some welds, known as autogenous welds, are carried out without the need for filler wire.

The TIG welding process can be either AC or DC, The ET200PACDC is a AC/DC TIG machine, AC (Alternating Current) for welding aluminium and DC machines (Direct Current) for welding steel, stainless steel, copper etc.

Connect the TIG torch connector to the “-” dinse socket on the machine front panel and rotate clockwise to tighten.

Connect the switch plug on the TIG torch to the corresponding socket on the machine panel, locate the 9 pin plug to the socket and rotate the locking ring clockwise to secure in place.

Insert the dinse plug on the work return cable into the “+” socket on the front panel of the machine and rotate clockwise to tighten.

Attach the work clamp to the work piece.

Connect the gas hose of the TIG torch to the quick connector on the machine front.

Connect the supply gas hose to the gas inlet on the back panel of the machine. Connect the other end of the supply hose to the gas regulator output on the cylinder.

Access and activate gas test mode via the control panel to check and set the gas flow.

Adjust the welding current according to the thickness of the work piece to be welded (for a guide to welding parameters, please refer to the table below).

Hold the torch 2-4mm away from the work piece and then press the torch trigger.

After the arc is ignited, the HF discharge will cease, the current will maintain at the preset value and welding can be carried out.

After releasing the torch trigger, the welding arc stops but gas will continue flowing for the post flow time set, welding then ends.

The amperage guide for TIG welding tungsten sizes can vary depending on material, work piece thickness, welding position and joint form.

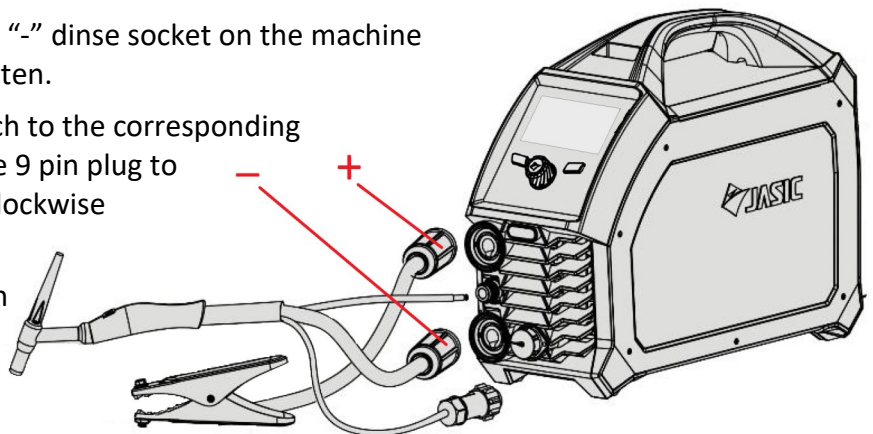
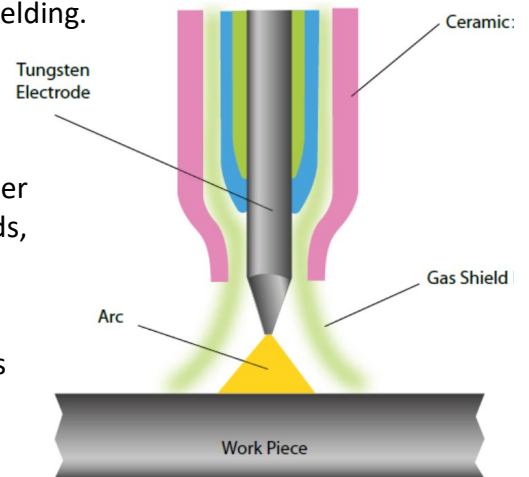

Tungsten Size	DC – Electrode Negative
1.0mm	15 – 80A
1.6mm	70 – 150A
2.4mm	150 – 250A
3.2mm	250A – 400A
4.0mm	400A – 500A
6.0mm	750A – 1000A

OPERATION - TIG



Before starting any welding activity ensure that you have suitable eye protection and protective clothing. Also take the necessary steps to protect any persons within the welding area.

TIG DC operation steps

From the home screen, rotate the control dial to highlight DC TIG mode and then pressing the control dial button will take you to the DC TIG control mode screen (as shown below).

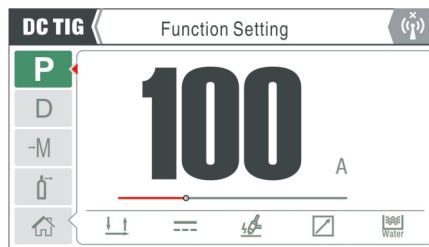
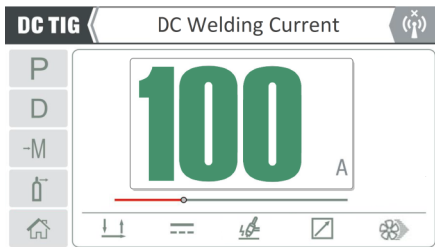

To select TIG features like, trigger mode, pulse, arc starting and TIG torch cooling type you need to access the welding Function Setting which is noted by the icon 'P' (see pages 20 and page 25 for further instruction).

On entering the Functions Settings screen,* you will note the relevant row of function setting icons as shown below.



Rotating the control dial clockwise will scroll you through the options and pressing the control dial button will enter you to your selected choice screen and as above from left to right is: trigger mode, pulse mode, arc starting mode and water cooled control.

For example, I have shown below the torch trigger and arc striking modes.

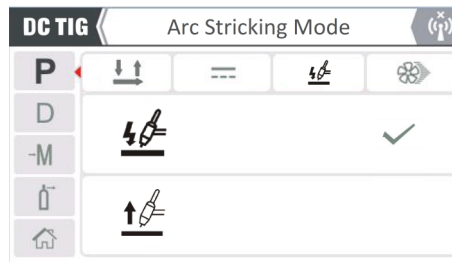

Once you have entered the chosen mode screen, you will see your options and the currently selected choice which has a tick alongside.

Pressing the control dial button, then rotating the dial will scroll through the choices on offer. Once set on your required choice, pressing the control dial button will save your chosen setting (confirmed by a tick) and return you to the previous setting of highlighting the trigger icon green where you can then rotate the control dial to select the next function setting you wish to adjust.

* Please Note:

The available options within the Functions Settings screen can change depending on which TIG welding mode is selected i.e. DC, AC or MIX TIG.

OPERATION - TIG



Before starting any welding activity ensure that you have suitable eye protection and protective clothing. Also take the necessary steps to protect any persons within the welding area.

TIG DC operation steps

To select TIG welding parameter features like, pre-gas, slope up pulse current background setting and more you need to access the welding Function Setting which is noted by the icon 'D' (see page 24 for further instruction).

On entering the Parameter Settings screen, you will note the DC TIG relevant row of function setting icons.

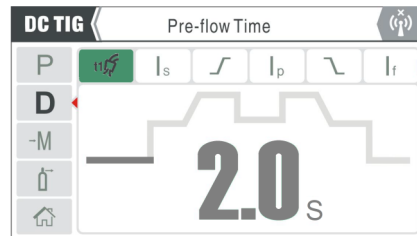

Image 1







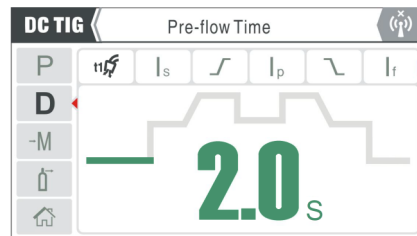

Image 2

You will note in image 1 the small red arrow which denotes that there are more parameters available to adjust the red arrow to the right of the image above will be visible and rotating the control dial will scroll you through the full selection choice (see image 2).

To select pre-flow gas time setting, rotate the control dial until the pre-gas icon is highlighted (as above), then press the control dial button and the green highlight will now change to the parameter setting where by rotating the control dial you will adjust the pre flow time shown in the image right. Pre-flow adjustment range is 0 ~ 3 seconds.



Follow the above 'pre-flow gas' adjustment and setting procedure to select and set the following TIG procedures:

-  Initial start current setting and the start current adjustment range is 5 ~ 200 amps (230v mode).
-  Upslope time setting and the upslope time adjustment range is 0 ~ 10 seconds.
-  Welding current setting and the welding current adjustment range is 10 ~ 200 amps (230v mode).
-  Downslope time setting and the downslope time adjustment range is 0 ~ 10 seconds.
-  Final amps (crater current) setting and the final current adjustment range is 5 ~ 200 amps (230v mode).
-  Post-flow gas time setting and the post flow adjustment range is 0 ~ 15 seconds.
-  If Spot weld mode is selected then the option spot time will show and the spot time adjustment range is 0.1 ~ 10 seconds.

- After the parameters are set appropriately, open the gas valve of the cylinder and adjust the gas regulator to the desired gas flow.
- Keep the torch 2-4mm away from the work piece and then press the torch trigger.
- Gas will start to flow followed by the HF and the arc is ignited.
- Once the arc is ignited the HF will cease and the current rises up to the pre-set value and welding can be carried out.
- After releasing the torch trigger, the current begins to decrease automatically to the crater (final) current value.
- The welding arc stops with gas still flowing for the pre-set post flow time and welding ends.

OPERATION - TIG



Before starting any welding activity ensure that you have suitable eye protection and protective clothing. Also take the necessary steps to protect any persons within the welding area.

TIG DC pulse operation steps

To turn pulse control on or off when in DC TIG mode, first you need to access this option from the welding function setting section which is identified by the 'P' symbol, see image 1 below.

On entering this function and rotating the control dial clockwise you will scroll you through all options available that are highlighted in turn green. When selecting pulse option, press the control dial button and you will enter the pulse control screen as shown in image 2.

Here you have the option of turning pulse on or off, rotate the control dial until the bottom tab is highlighted green and press the control dial button, this will move the confirmation tick to the bottom tab as shown in image 2.

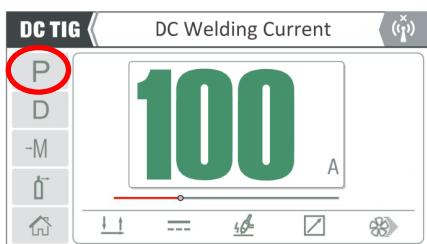

Image 1

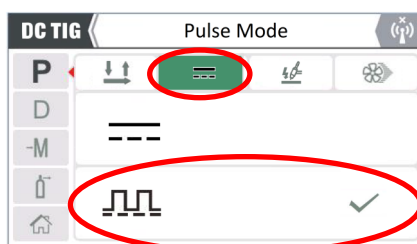

Image 2

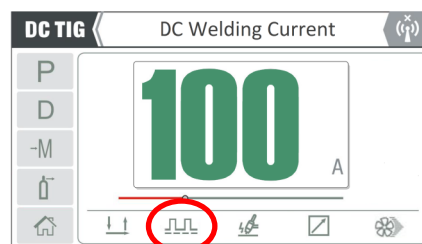

Image 3

Pressing the back button will now take you back to the main DC TIG control screen as shown in image 3 and you will now note that the pulse symbol illuminated which informs the operator that TIG pulse is now active.

Proceed with the setting up of pre gas, upslope, welding current, downslope time, final (crater) current and post flow gas time as per standard TIG DC (See page 38).

NOTE: In pulse mode, the welding current setting now becomes the peak welding current of the pulse.

Now pulse mode is active, you now need to select the TIG pulse additional welding parameter and to facilitate this, you need to again access the welding Function Setting which is noted by the icon 'D' (see page 24 for further instruction).

On entering the Parameter Settings screen, you will note the additional pulse features function setting icons.

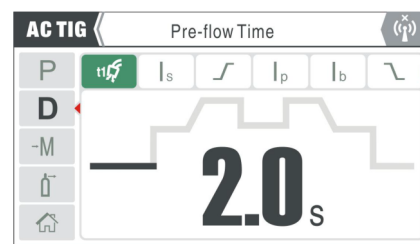

Image 1



Image 2

You will note in image 1 above the small red arrow which denotes that there are more parameters available to adjust the red arrow to the right of the image above will be visible and rotating the control dial will scroll you through the full selection choice (see image 2).

To select these parameters, rotate the control dial until the pre-gas icon is highlighted green (as above), you can now scroll through all the parameter options by rotating the control dial, when you wish to adjust your selected parameter, press the control dial button and then rotate the dial to adjust selected setting. See the following page for more detail a DC pulse settings.

OPERATION - TIG



Before starting any welding activity ensure that you have suitable eye protection and protective clothing. Also take the necessary steps to protect any persons within the welding area.

TIG DC pulse operation steps

When in DC TIG mode with pulse turned ON, you will note the addition pulse parameters circled in red below.



Image 1



Image 2

And these are listed in a little more detail below:

I_p

The welding current setting now becomes the peak welding current which has an adjustment range of 5 ~ 200 amps (230v mode).

The next step is to select and adjust the additional pulse parameters and these are only seen when the pulse mode is selected.

I_b

To select the background current (base or low pulse), rotate the dial until the base current icon is highlighted green, then press the dial and the base current is now highlighted green, then rotating the control dial will adjust the background current and the adjustment range of 5 ~ 200 amps. (230v mode).



To select and set pulse frequency, rotate the dial until the pulse icon is highlighted green, then press the dial and the pulse Hz is now highlighted green and then rotating the control dial will adjust the pulse frequency rate between 0.5Hz to 200Hz.



To select and set the pulse ratio (width), rotate the dial until the pulse width is highlighted green, then press the dial and the width % is now highlighted green and then by rotating the control dial will adjust the pulse ratio rate between 10% ~ 90% .

- After the parameters are set appropriately, open the gas valve of the cylinder and adjust the gas regulator to the desired gas flow.
- Keep the torch 2-4mm away from the work piece and then press the torch trigger.
- Gas will start to flow followed by the HF and the arc is ignited.
- Once the arc is ignited the HF will cease and the current rises up to the pre-set value and welding can be carried out.
- After releasing the torch trigger, the current begins to decrease automatically to the crater (final) current value.
- The welding arc stops with gas still flowing for the pre-set post flow time and welding ends.

Please Note:

When a parameter setting has been selected and adjusted, the screen will default back to the welding current setting when no other control have been touched after approximately 2 seconds.

JASIC TIG200PACDC LCD - DC TIG - Quick Set-Up Guide

For DC TIG welding, set up as below, ensure you place the machine in DC TIG, 2T trigger mode, Pulse turned OFF, HF ON and current control set to Local/panel control and depending on TIG torch type fitted either water or air cooled set (for this example water cooled is set).

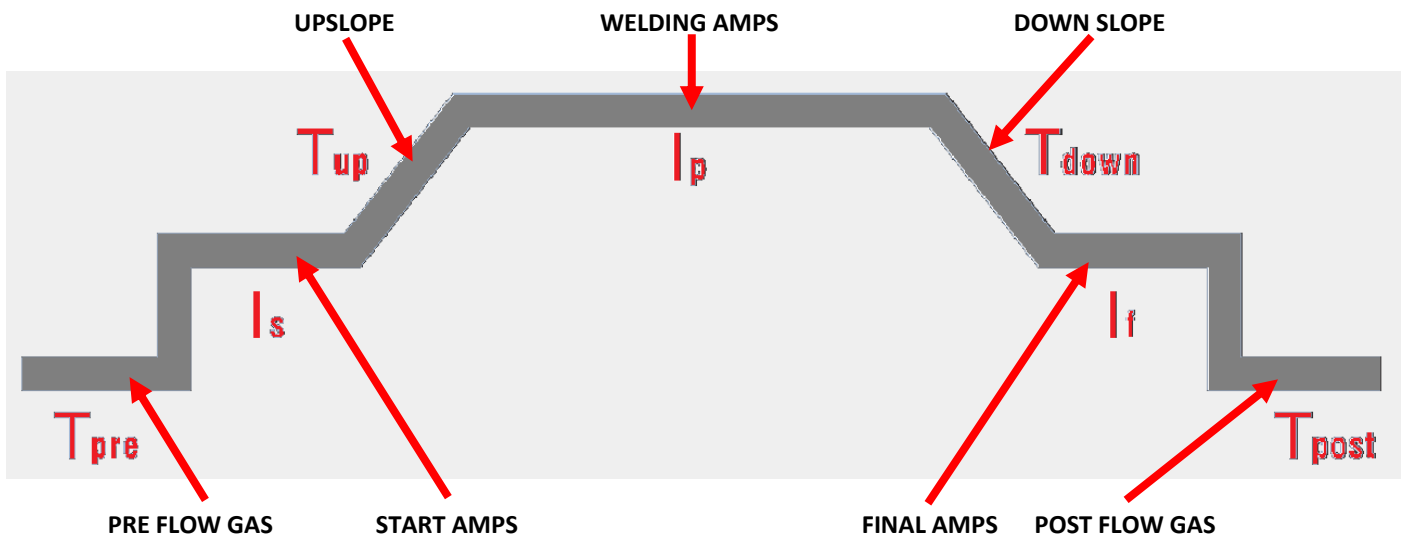
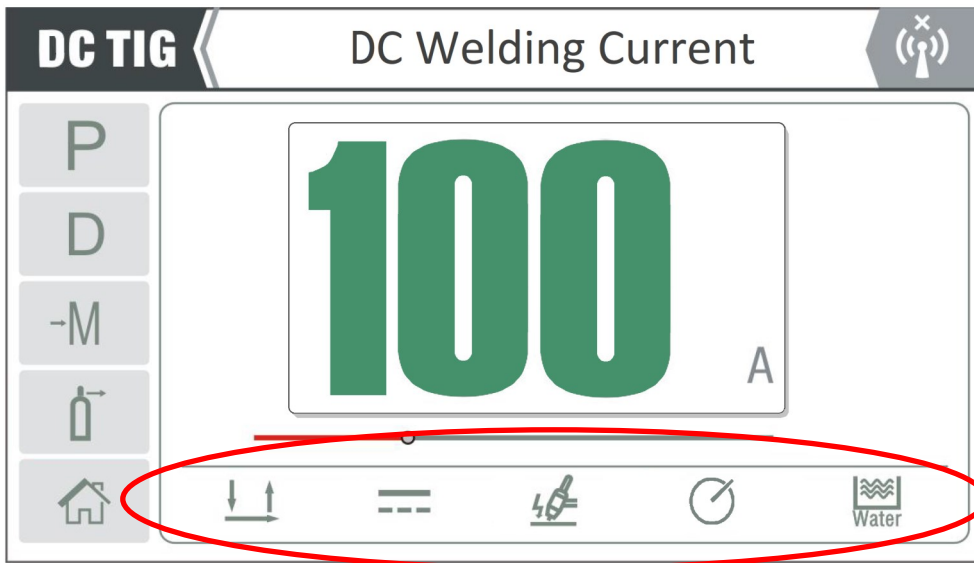

Set parameters as follows using control panel image above as reference

Parameter	Units	Adjustable Range	Guide Setting	User Setting
Job/Material	---	---	---	
PRE-GAS TIME	Seconds	0 ~ 3	0.5	
START-CURRENT	Amps	5 ~ 200	15	
UP-SLOPE TIME	Seconds	0 ~ 10	0	
PEAK WELDING AMPS *	Amps	5 ~ 200	User defined *	
DOWN-SLOPE TIME	Seconds	0 ~ 10	1	
FINAL CURRENT	Amps	5 ~ 200	10	
POST-GAS TIME	Seconds	0 ~ 10	2	

* Depends on material thickness (30A per mm) eg. 3mm = 90A

JASIC TIG200PACDC LCD - DC TIG PULSE - Quick Set-Up Guide

For DC TIG welding, set up as below, ensure you place the machine in DC TIG, 2T trigger mode, Pulse turned ON, HF ON and current control set to Local/panel control and depending on TIG torch type fitted either water or air cooled set (for this example air cooled is set).

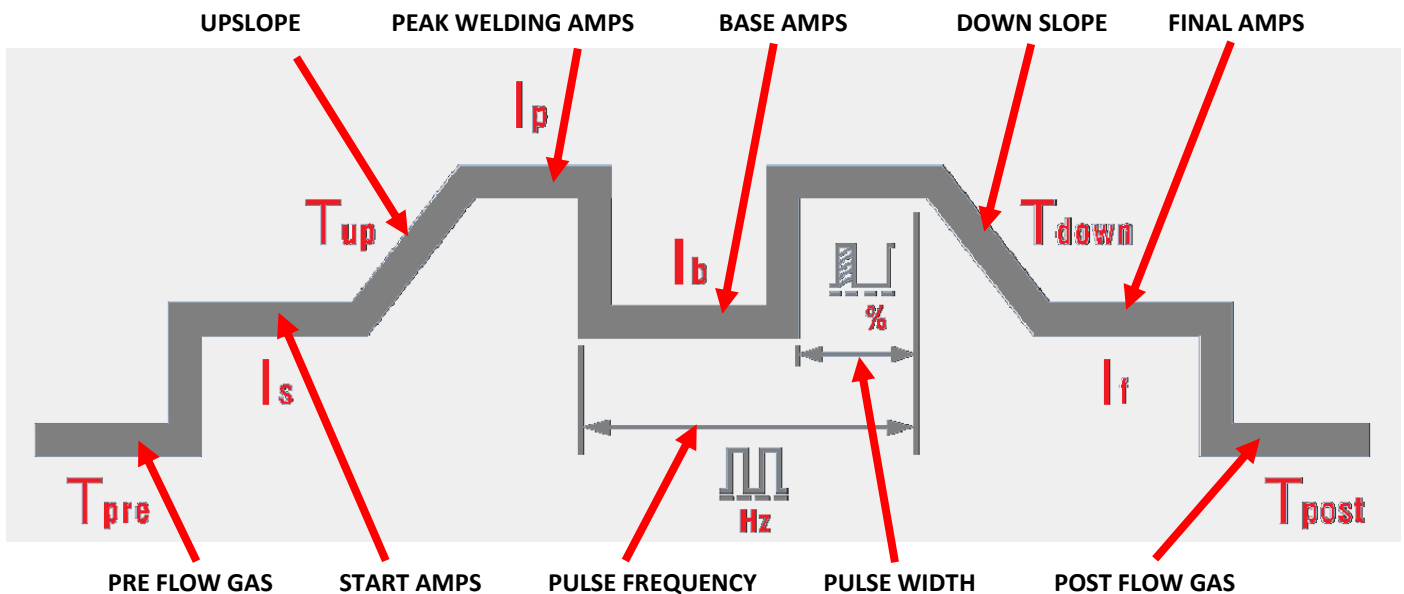
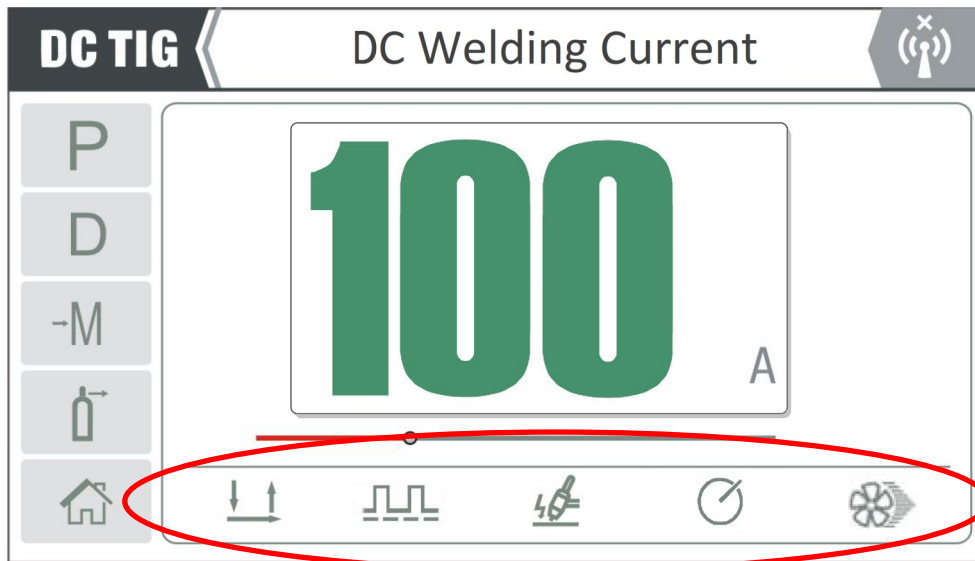

Set parameters as follows using control panel image above as reference

Parameter	Units	Adjustable Range	Guide Setting	User Setting
Job/Material	---	---	---	
PRE-GAS TIME	Seconds	0 ~ 3	0.5	
START-CURRENT	Amps	5 ~ 200	15	
UP-SLOPE TIME	Seconds	0 ~ 10	0	
PEAK WELDING AMPS *	Amps	5 ~ 200	User defined *	
BASE CURRENT **	Amps	5 ~ 200	50% **	
PULSE FREQUENCY	Hz	0.5 ~ 200	1	
PULSE WIDTH	%	10 ~ 90	50	
DOWN-SLOPE TIME	Seconds	0 ~ 10	1	
FINAL CURRENT	Amps	5 ~ 200	10	
POST-GAS TIME	Seconds	0 ~ 10	2	

* Depends on material thickness (30A per mm) eg. 3mm = 90A

** Set base current to 50% of your peak welding current

OPERATION - TIG



Before starting any welding activity ensure that you have suitable eye protection and protective clothing. Also take the necessary steps to protect any persons within the welding area.

TIG AC operation steps

From the home screen, rotate the control dial to highlight AC TIG mode and then pressing the control dial button will take you to the AC TIG control mode screen (as shown below).

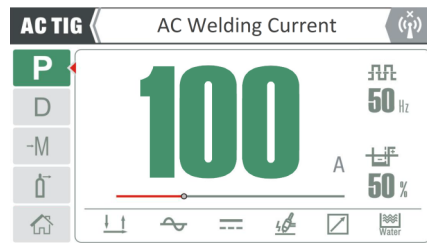
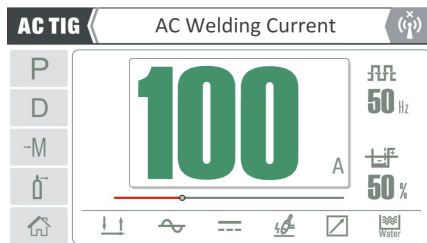

As with DC TIG, to select features like, trigger mode, pulse, arc starting and TIG torch cooling type you need to access the welding Function Setting which is noted by the icon 'P' (see page 25 for further instruction) and for the above example as shown in the bottom bar of icons, we have selected 2T torch trigger, sinusoidal waveform, pulse off, remote current control and water cooling on.

On entering the Functions Settings screen (P),* you will note the relevant row of function setting icons as shown below and that in AC mode you have the additional parameter of AC waveform selection which is circled in red below.



Rotating the control dial clockwise will scroll you through the options and pressing the control dial button will enter you to your selected choice screen and as above from left to right shows is;

- Trigger mode,
- AC waveform,
- Pulse mode,
- Arc starting mode
- Water cooled control.

The example shown right, shows the AC waveform options which when selected lists the waveform choices underneath, you can see that AC square wave is the currently selected choice which has a tick alongside, from here you can also select sawtooth or sinusoidal waveforms and for further information on AC waveforms, please see page 20.

Pressing the control dial button, then rotating the dial will scroll through the other choices on offer. Once set on your required choice, pressing the control dial button will save your chosen setting (confirmed by a tick) and return you to the previous setting of highlighting the trigger icon green where you can then rotate the control dial to select the next function setting you wish to adjust.

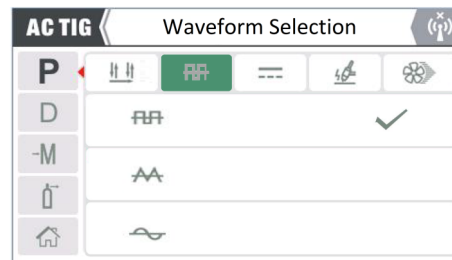

* Please Note:

The available options within the Functions Settings screen can change depending on which TIG welding mode is selected i.e. DC, AC or MIX TIG.

OPERATION - TIG



Before starting any welding activity ensure that you have suitable eye protection and protective clothing. Also take the necessary steps to protect any persons within the welding area.

TIG AC operation steps

To select TIG welding parameter features like, pre-gas, slope up pulse current background setting and more you need to access the welding Function Setting which is noted by the icon 'D' (see page 24 for further instruction)

On entering the Parameter Settings screen, you will note the AC TIG relevant row of function setting icons.

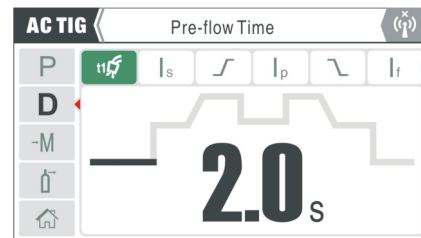

Image 1









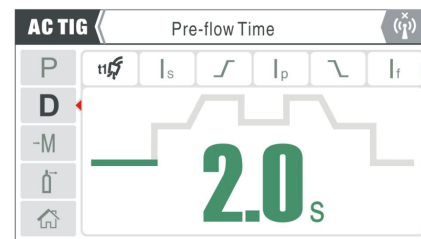

Image 2

You will note in image 1 the small red arrow which denotes that there are more parameters available to adjust the red arrow to the right of the image above will be visible and rotating the control dial will scroll you through the full selection choice (see image 2).

To select pre-flow gas time setting, rotate the control dial until the pre-gas icon is highlighted (as above), then press the control dial button and the green highlight will now change to the parameter setting where by rotating the control dial you will adjust the pre flow time shown in the image right. Pre-flow adjustment range is 0 ~ 3 seconds.



Follow the above 'pre-flow gas' adjustment and setting procedure to select and set the following TIG procedures:

-  Initial start current setting and the start current adjustment range is 5 ~ 200 amps (230v mode).
-  Upslope time setting and the upslope time adjustment range is 0 ~ 10 seconds.
-  Welding current setting and the welding current adjustment range is 10 ~ 200 amps (230v mode).
-  Downslope time setting and the downslope time adjustment range is 0 ~ 10 seconds.
-  Final amps (crater current) setting and the final current adjustment range is 5 ~ 200 amps (230v mode).
-  Post-flow gas time setting and the post flow adjustment range is 0 ~ 15 seconds.
-  This icon represents AC TIG frequency, the AC frequency adjustment range is 20 ~ 250Hz.
-  This icon signifies AC wave balance and the AC balance adjustment range is 20 ~ 60% with the balanced zero point being 40.

Please Note:

When a parameter setting has been selected and adjusted, the screen will default back to the welding current setting when no other control have been touched after approximately 2 seconds.

OPERATION - TIG



Before starting any welding activity ensure that you have suitable eye protection and protective clothing. Also take the necessary steps to protect any persons within the welding area.

TIG AC operation steps continued

- After the parameters are set appropriately, open the gas valve of the cylinder and adjust the gas regulator to the desired gas flow.
- Keep the torch 2-4mm away from the work piece and then press the torch trigger.
- Gas will start to flow followed by the HF and the arc is ignited.
- Once the arc is ignited the HF will cease and the current rises up to the pre-set value and welding can be carried out.
- After releasing the torch trigger, the current begins to decrease automatically to the crater (final) current value.
- The welding arc stops with gas still flowing for the pre-set post flow time and welding ends.

AC wave forms

Pressing the AC wave button will allow you to scroll through 3 wave types used in AC welding, the waveform selections are:

1. Square wave
2. Triangle wave
3. Sine wave



Depending on your selection the corresponding LED indicator will illuminate.

Waveforms summary:

The waveform selection should be made to meet a specific requirement or operator preference and the waveforms available with the ET-200PACDC are as follows:

AC square wave:

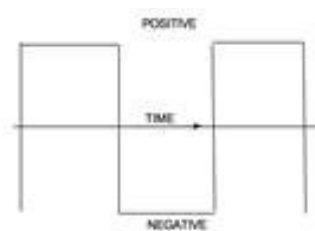

This provides fast transitions which provide a responsive and dynamic arc. The fast transitions eliminate the need for continuous HF. The focused arc provides good directional control.

Square wave offers improved cleaning of the oxide film on aluminium, more power and penetration, giving fast puddle freezing along with deep penetration and fast travel speeds.

Triangular wave:



The triangular wave provides the required peak amperage but the waveform shape has the effect of reducing the heat input. This reduction in heat input makes it particularly suited to thin material welding.

Triangle wave is ideally suited to thinner materials as it reduces the heat input especially in vertical or overhead joints and require to have the puddle freeze quickly! It also allows for faster travel speeds.

AC sine wave:



The sine wave gives the operator a softer feel arc similar to that of the older conventional power source. The arc tends to be much wider than the square wave arc.

The sine wave AC waveform is like the older transformer type TIG welding machines which mimic's the AC TIG welding performance of 'transformer' type machines for that similar traditional arc performance.

OPERATION - TIG



Before starting any welding activity ensure that you have suitable eye protection and protective clothing. Also take the necessary steps to protect any persons within the welding area.

TIG AC operation steps

Mix (Hybrid) mode:

The 'hybrid' mix AC TIG mode allows for the selected AC waveform to be mixed with a positive element which increases the cleaning action of aluminium oxides along with increasing welding speeds. When the mixed indicator is ON, this indicates that the machine is in Mix AC DC mode and the additional Mix controls will be active. Mixed AC-DC output is suitable for welding thicker aluminium, magnesium and their alloys.

The MIX TIG welding option offers a combination of either:

1. Square wave and DC
2. Triangle wave and DC
3. Sine wave and DC

Please Note:

When mix mode is active, pulse control is deactivated and will not show as an option.



AC Waveform selection:

When in AC MIX TIG mode, you can still scroll through the 3 wave types used in AC welding, Square wave, Triangle wave and Sine wave. These 3 waveforms are easily changed by pressing the wave waveform button (shown left) and depending on your selection the corresponding LED indicator will illuminate.

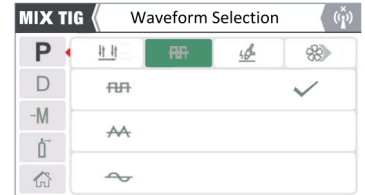

On entering the Parameter Settings screen, you will note for AC MIX TIG the relevant row of function setting icons.

In image 1 (below) the small red arrow denotes that there are more parameters settings available and are accessed by rotating the control dial which will scroll you through the full selection choice (see image 2).

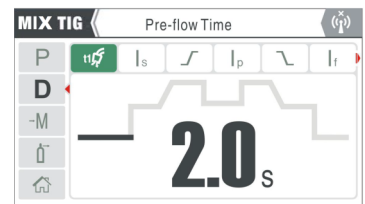

Apart from the 2 circled parameters below, the rest of the parameters are as AC TIG as per [page 53](#)



Mixed frequency parameter and adjustment.



To select and set the mix frequency, rotate the control dial until the mix frequency icon is highlighted and then press the control dial button, then by rotating the control dial you will be able to adjust the mix frequency rate between the range of 10% ~ 90% .

Mixed duty-cycle parameter and adjustment.



To select and set the ratio of DC time, rotate the dial until the mix duty icon is highlighted, then press the control dial button, then by rotating the control dial you will be able to adjust the mix duty cycle % between the range of 10% ~ 90% .

JASIC TIG200PACDC LCD - AC TIG - Quick Set-Up Guide

For DC TIG welding, set up as below, ensure you place the machine in AC TIG, 2T trigger mode, AC sine wave, Pulse turned OFF, HF ON and current control set to Local/panel control and depending on TIG torch type fitted either water or air cooled set (for this example water cooled is set).

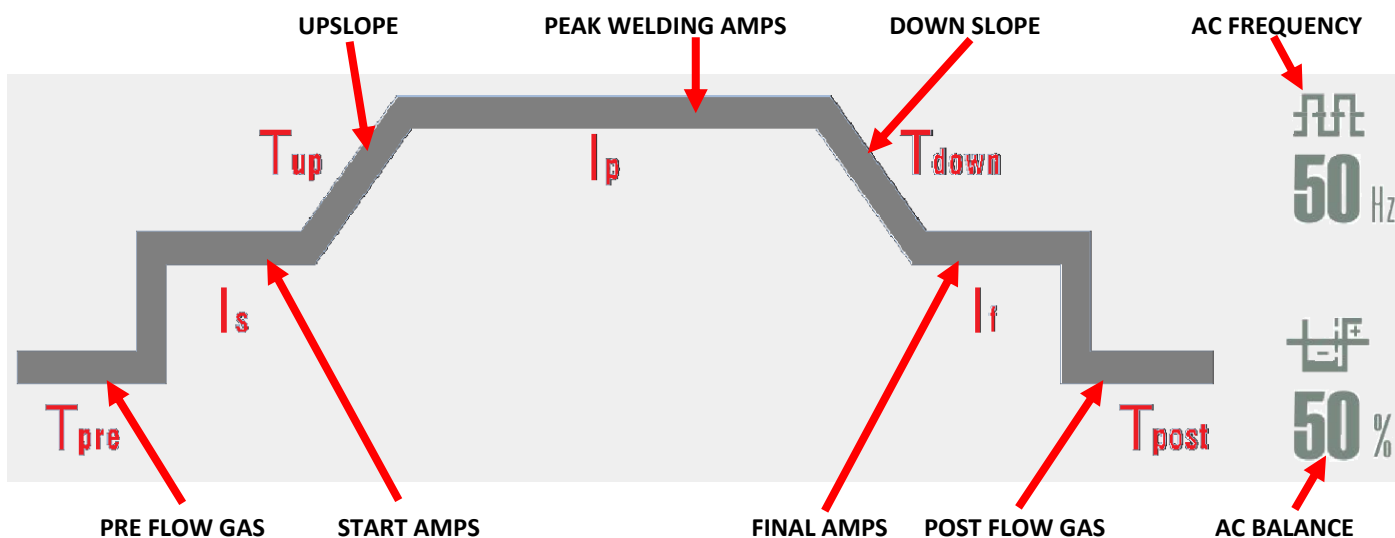
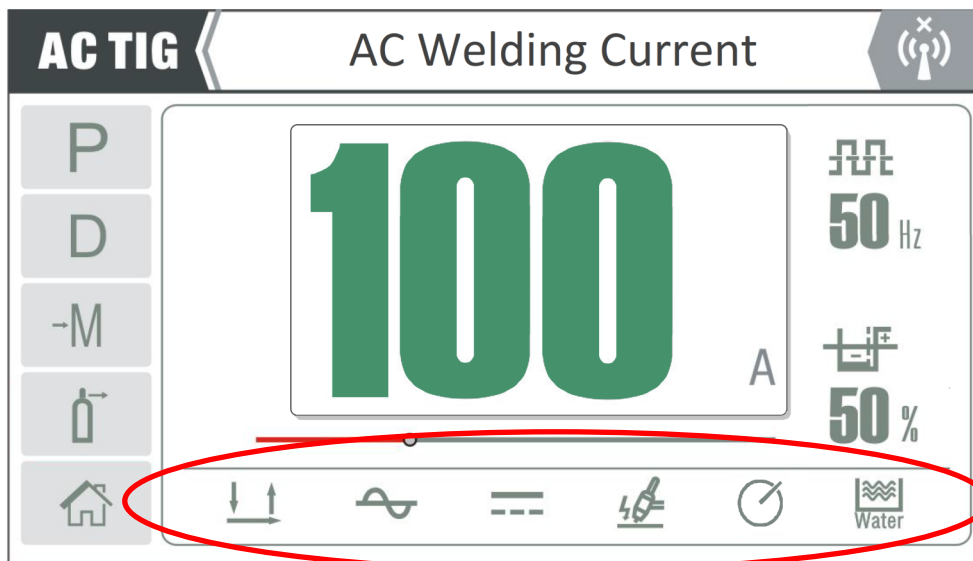

Set parameters as follows using control panel image above as reference

Parameter	Units	Adjustable Range	Guide Setting	User Setting
Job/Material	---	---	---	
PRE-GAS TIME	Seconds	0 ~ 3	0.5	
START-CURRENT	Amps	5 ~ 200	20	
UP-SLOPE TIME	Seconds	0 ~ 10	0	
PEAK WELDING AMPS *	Amps	5 ~ 200	User defined *	
AC FREQUENCY	Hz	20 ~ 200	70	
AC BALANCE	%	20 ~ 60	40	
DOWN-SLOPE TIME	Seconds	0 ~ 10	1	
FINAL CURRENT	Amps	5 ~ 200	10	
POST-GAS TIME	Seconds	0 ~ 15	3	

* Depends on material thickness (30A per mm) eg. 3mm = 90A

JASIC TIG200PACDC LCD - AC TIG PULSE - Quick Set-Up Guide

For DC TIG welding, set up as below, ensure you place the machine in AC TIG, 2T trigger mode, AC sine wave, Pulse turned ON, HF ON and current control set to Local/panel control and depending on TIG torch type fitted either water or air cooled set (for this example water cooled is set).

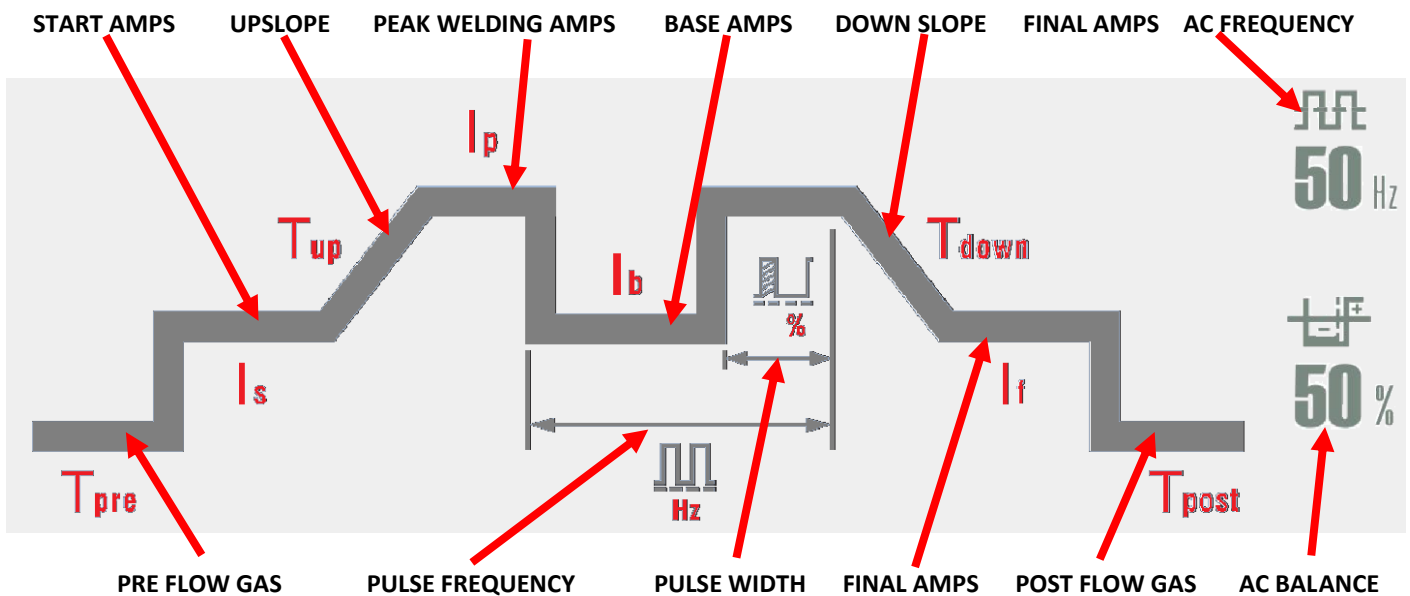
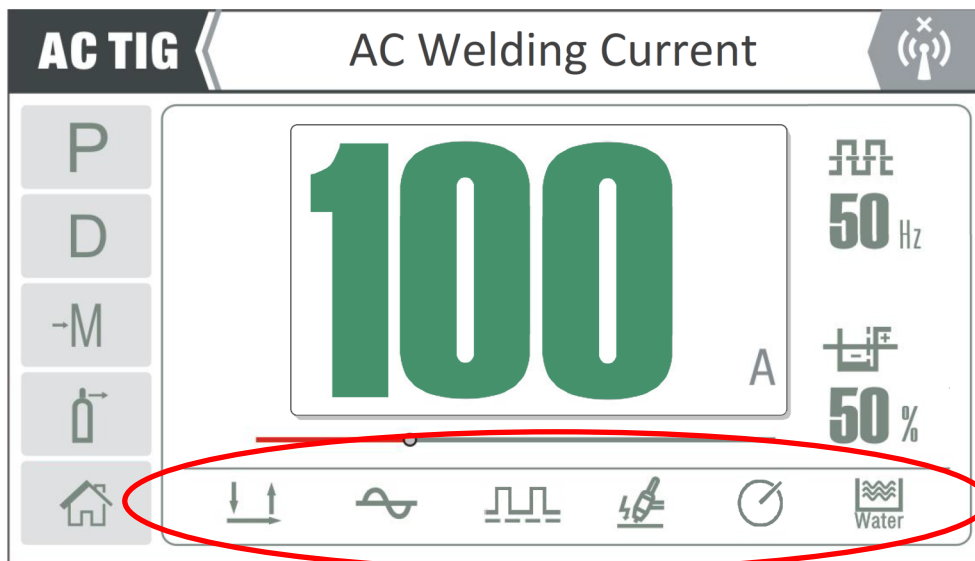

Set parameters as follows using control panel image above as reference

Parameter	Units	Adjustable Range	Guide Setting	User Setting
Job/Material	---	---	---	
PRE-GAS TIME	Seconds	0 ~ 3	0.5	
START-CURRENT	Amps	5 ~ 200	20	
UP-SLOPE TIME	Seconds	0 ~ 10	0	
PEAK WELDING AMPS*	Amps	5 ~ 200	User defined *	
BASE AMPS**	Amos	5 ~ 200	50% **	
AC FREQUENCY	Hz	20 ~ 200	70	
AC BALANCE	%	20 ~ 60	40	
PULSE FREQUENCY	Hz	0.2 ~ 200	1	
PULSE WIDTH	%	10 ~ 90	50	
DOWN-SLOPE TIME	Seconds	0 ~ 10	1	
FINAL CURRENT	Amps	5 ~ 200	10	
POST-GAS TIME	Seconds	0 ~ 15	3	

* Depends on material thickness (30A per mm) eg. 3mm = 90A

** Set base current to 50% of your peak welding current

OPERATION - TIG



Before starting any welding activity ensure that you have suitable eye protection and protective clothing. Also take the necessary steps to protect any persons within the welding area.

TIG torch trigger operation steps

- Tab for 2T →
- Tab for 4T →
- Tab for Cycle mode →
- Tab for spot mode →

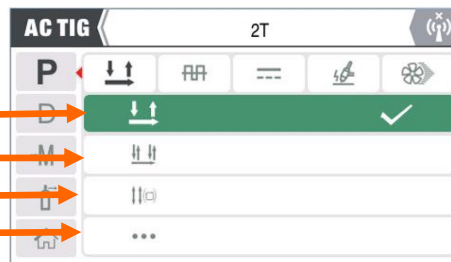

2T mode (normal trigger control)

The 2T (↑↓) LED light will illuminate when the power source is in 2T welding mode. In this mode, the torch trigger must remain pressed (closed) for the welding output to be active. See example below:

Press and hold the torch trigger to activate the power source, the gas valve and gas will flow. After the gas pre flow time ends, HF discharge begins and then the welding arc will ignite and then the current rises up (slope up time) to the welding current value gradually until you achieve the preset welding current.

When the torch switch is released, the current begins to drop gradually (slope down time) and when it drops to the minimum current value, the welding output is cut off and the gas valve will close, once the post flow time ends, this is the end of the welding process.

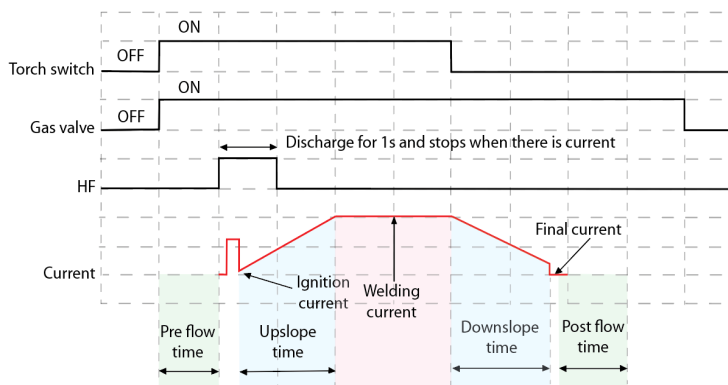

4T (latch trigger control)

The 4T (⇅) LED will illuminate when the power source is in 4T welding mode, this trigger mode is mainly used for long welding runs to assist in reducing operator finger fatigue.

In this mode the user can press and release the torch trigger and the output will remain active until the trigger switch is depressed again and released.

In 4T mode, the gas valve opens when the torch switch is pressed down, after the pre flow time ends, HF discharge occurs which ignites the welding arc. Once the welding arc has successfully ignited the initial current value is active and the torch switch can now be released, the welding current rises up to the preset welding current value gradually and you will continue to weld your material.

To finish welding, simply press the torch switch down again and the current will begin to gradually drop (slope out time) to the final current value. When the torch switch is released the current output is cut off and the gas will continue to flow until your preset post flow time has elapsed.

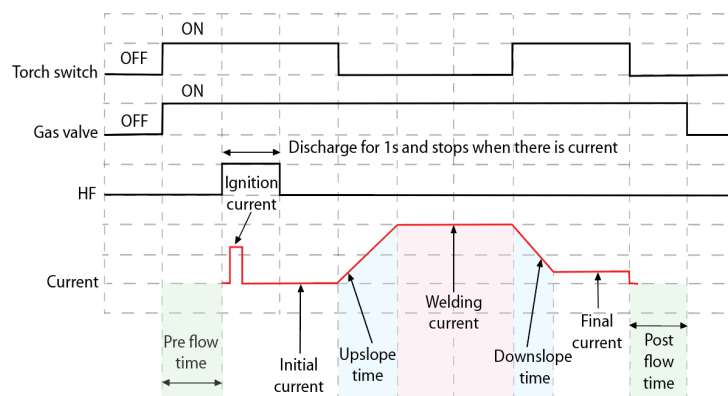

OPERATION - TIG



Before starting any welding activity ensure that you have suitable eye protection and protective clothing. Also take the necessary steps to protect any persons within the welding area.

TIG torch trigger operation steps

Cycle mode

The cycle \updownarrow (□) LED light will illuminate when the power source is in repeating mode, upon pressing the torch trigger switch the gas valve opens and after the pre flow time ends, HF discharge will engage the welding arc. Once the welding arc is ignited successfully, the initial current is present then after the operator releases the torch switch the welding current rises up to the preset welding current value gradually (depending on preset upslope time). When the torch switch is pressed down again, the current begins to drop gradually to the final current arc value. When the torch switch is released again, the current will rise gradually up to the welding current value again. 'Cycle' means the welding current varies between the final arc current value and the welding current value.

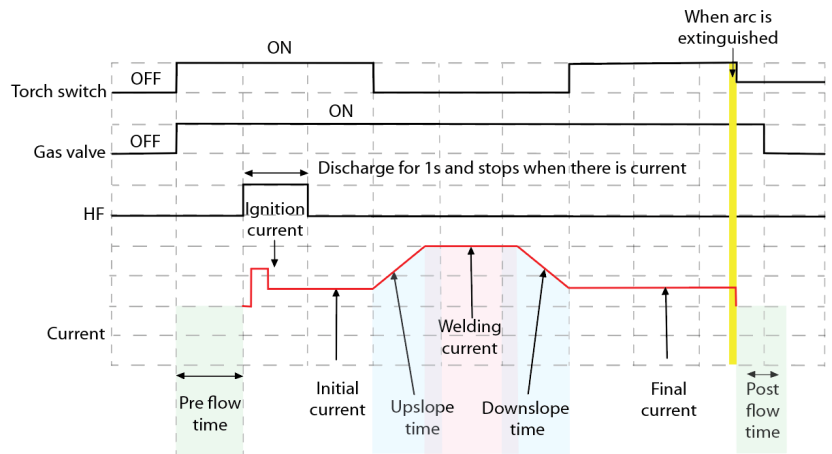

To extinguish the welding arc, press and release the torch trigger briefly (within 1/5 of a second) and the arc will be extinguished immediately and the current output will be shut off. The gas valve will then close when the post flow time ends and the welding process ends.

Spot welding mode

The spot ●●● LED will illuminate when the power source is in spot welding mode. To set the spot welding time setting, refer to page 22 for selecting and setting the spot time.

On pressing the torch trigger, gas will flow and at the end of the gas pre-flow time HF will initiate the welding arc. Once the welding arc is ignited the welding current is present and no matter if the torch switch is on or off the machine will still offer welding current until the preset spot welding time the user set has timed out and then the welding arc will be extinguished.

The gas will continue until the post flow time ends when the welding process ends.

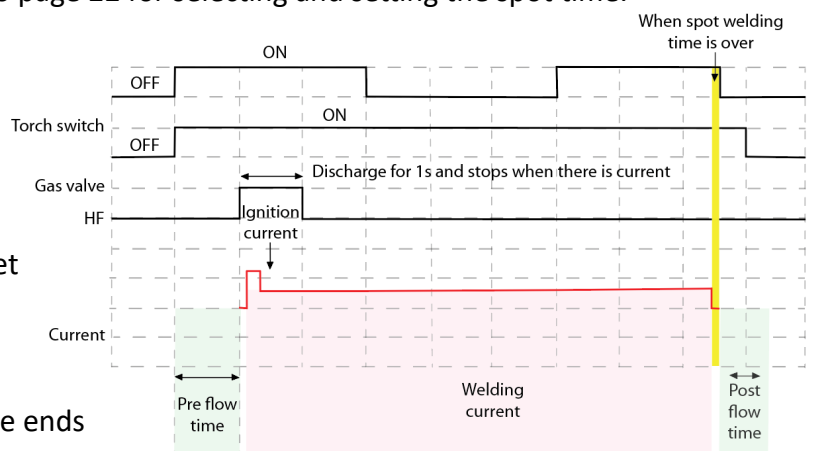

Please note:

The spot welding option can only be carried out in HF TIG mode only.

FUNCTION TABLE

When the machine is either welding or not, you are able to access the below welding parameters by rotate the control dial to select the optional parameters as required and adjustment can be carried out without affecting welding.

"✓" indicates that the parameter is optional, and "✗" indicates that it is not optional.

Welding Mode	Trigger Mode	Pre-flow time	Initial Current	Upslope Time	Peak Current	Base Current	Downslope Time	Final Current	Post-flow time	Spot Time	AC Frequency	AC Balance	Pulse Frequency	Pulse Duty Factor
DC TIG	2T	✓	✓	✓	✓	✗	✓	✓	✓	✓	✗	✗	✗	✗
	4T	✓	✓	✓	✓	✗	✓	✓	✓	✓	✗	✗	✗	✗
	Repeat	✓	✓	✓	✓	✗	✓	✓	✓	✓	✗	✗	✗	✗
	Spot Welding	✓	✗	✗	✓	✗	✗	✗	✓	✓	✗	✗	✗	✗
DC PULSE TIG	2T	✓	✓	✓	✓	✓	✓	✓	✓	✗	✗	✗	✓	✓
	4T	✓	✓	✓	✓	✓	✓	✓	✓	✗	✗	✗	✓	✓
	Repeat	✓	✓	✓	✓	✓	✓	✓	✓	✗	✗	✗	✓	✓
AC TIG	2T	✓	✓	✓	✓	✗	✓	✓	✓	✗	✓	✓	✗	✗
	4T	✓	✓	✓	✓	✗	✓	✓	✓	✗	✓	✓	✗	✗
	Repeat	✓	✓	✓	✓	✗	✓	✓	✓	✗	✓	✓	✗	✗
	Spot Welding	✓	✗	✗	✓	✗	✗	✗	✓	✓	✓	✓	✗	✗
AC PULSE TIG	2T	✓	✓	✓	✓	✓	✓	✓	✓	✗	✓	✓	✓	✓
	4T	✓	✓	✓	✓	✓	✓	✓	✓	✗	✓	✓	✓	✓
	Repeat	✓	✓	✓	✓	✓	✓	✓	✓	✗	✓	✓	✓	✓
MIX TIG	2T	✓	✓	✓	✓	✗	✓	✓	✓	✗	✓	✓	✓	✓
	4T	✓	✓	✓	✓	✗	✓	✓	✓	✗	✓	✓	✓	✓
	Cycle	✓	✓	✓	✓	✗	✓	✓	✓	✗	✓	✓	✓	✓

TIG SETUP LIFT TIG



Before starting any welding activity ensure that you have suitable eye protection and protective clothing as, welding rays, spatter, smoke and high temperatures produced in the process may cause injury to personnel.

Also take the necessary steps to protect any persons within the welding area that may cause injury.

LIFT TIG welding torch and earth cable connection

Insert the cable plug with the work clamp into the “+” socket on the front panel of the Jasic welding machine and tighten clockwise.

Insert the cable plug of the TIG torch into the “-” socket on the front panel of the Jasic machine and tighten clockwise.

Connect the TIG torch gas hose to the gas outlet connection located on the front panel of the machine, also ensure you inlet hose is connected to the regulator which is located on the shield gas cylinder.

Connect the 9 pin TIG torch trigger switch plug to the matching control socket mounted on the front panel of the machine

Before starting any welding activity, please ensure that you have suitable eye protection and protective clothing. Also take the necessary steps to protect any persons within the welding area.

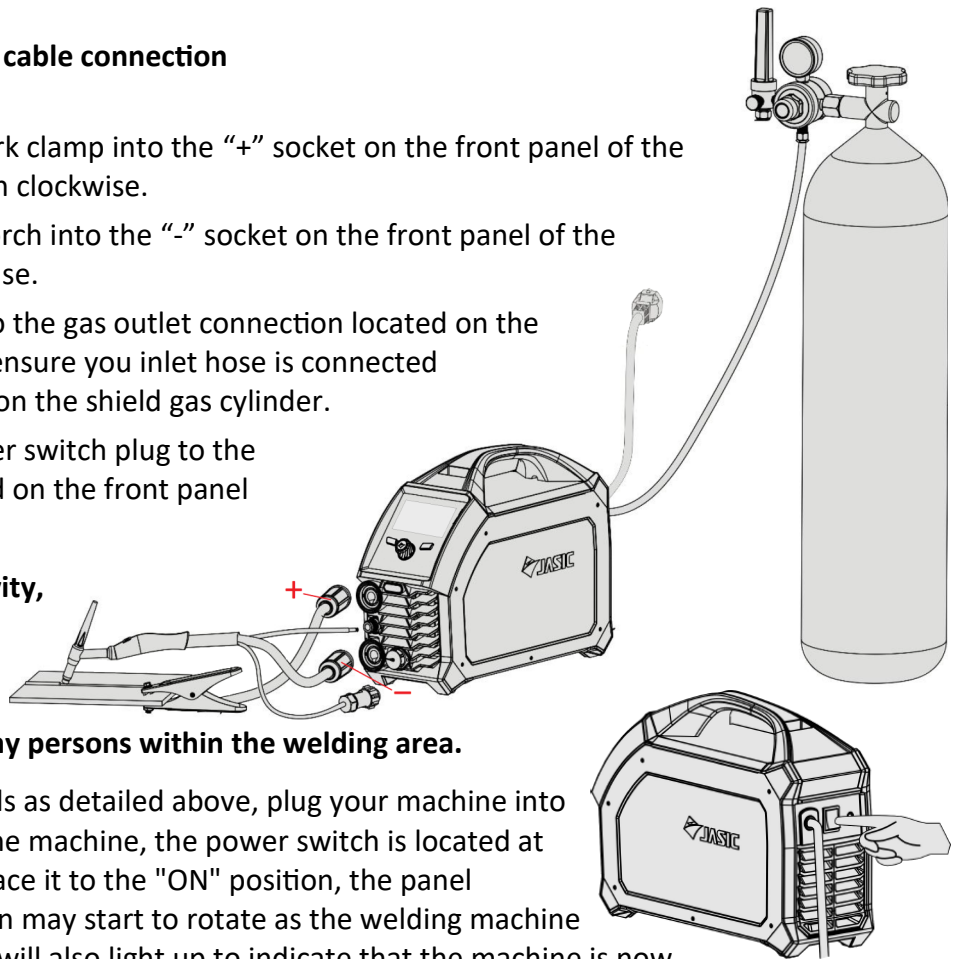

After connecting the welding leads as detailed above, plug your machine into the mains supply and turn ‘ON’ the machine, the power switch is located at the rear panel of the machine, place it to the "ON" position, the panel indicator will then light up, the fan may start to rotate as the welding machine powers up and the control panel will also light up to indicate that the machine is now ready to use as shown below.

Select DC TIG from the home screen, then navigate to the function settings icon ‘P’ by rotating the control dial (image 1) and pressing the control dial button to access the additional functions, navigate to the arc striking mode where you can select either HF TIG start or LIFT TIG mode.

(image 2) shows Lift TIG selected.

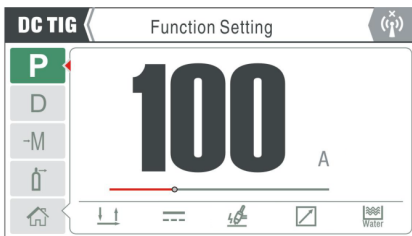

Image 1

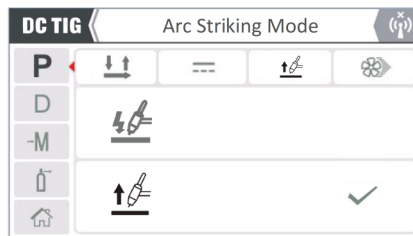

Image 2

On pressing your selection you will be taken back to the previous screen and you will not note that the striking icon on the bottom bar will show the Lift TIG symbol .

Set the welding parameters

TIG welding parameters can now be adjusted and set according to your welding requirements, see pages from 39 for further information.

LIFT TIG process

Press the TIG torch switch, then touch the tungsten electrode to the work piece for less than 2 seconds and then lift away to 2-4mm from the work piece and the welding arc is then established.

Once welding is complete release the torch trigger to disengage the welding arc, ensure to leave the torch in place to shield the weld with gas until the shield gas has automatically turned off.

GUIDE TO TIG WELDING



Before starting any welding activity ensure that you have suitable eye protection and protective clothing. Also take the necessary steps to protect any persons within the welding area.

TIG torch body and components

The torch body holds the various welding consumables in place as shown and is covered by either a rigid phenolic or rubberised covering.

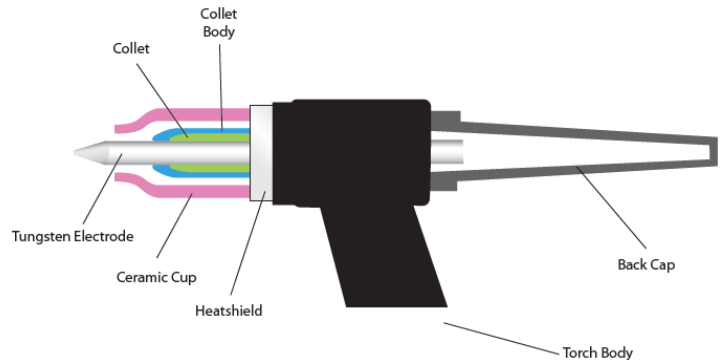

Collet body

 The collet body screws into the torch body. It is replaceable and is changed to accommodate the different sizes tungsten's and their respective collets.

Collets

 The welding electrode (tungsten) is held in the torch by the collet. The collet is usually made of copper or a copper alloy. The collet's grip on the electrode is secured when the torch back cap is tightened in place. Good electrical contact between the collet and tungsten electrode is essential for good welding current transfer.

Gas lens body

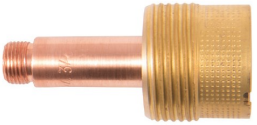
 A gas lens is a device that can be used in place of the normal collet body. It screws into the torch body and is used to reduce turbulence in the flow of shield gas and produce a stiff column of undisturbed flow of shielding gas. A gas lens will allow the welder to move the nozzle further away from the joint allowing increased visibility of the arc. A much larger diameter nozzle can be used which will produce a large blanket of shielding gas. This can be very useful in welding material like titanium. The gas lens will also enable the welder to reach joints with limited access such as inside corners.

Ceramic cups

 Gas cups are made of various types of heat resistant materials in different shapes, diameters and lengths. The cups are either screwed onto the collet body or gas lens body or in some cases pushed in place. Cups can be made of ceramic, metal, metal-jacketed ceramic, glass or other materials. The ceramic type is quite easily broken so take care when putting the torch down.

Gas cups must be large enough to provide adequate shielding gas coverage to the weld pool and surrounding area. A cup of a given size will allow only a given amount of gas to flow before the gas flow becomes disturbed due to the speed of flow. Should this condition exist the size of cup should be increased to allow the flow speed to reduce and once again establish an effective regular shield.

Back cap

The back cap screws into the rear on the torch head and applies pressure to the back end of the collet which in turn forces up against the collet body, the resulting pressure holds the tungsten in place to ensure it does not move during the welding process.

Back caps are made from a rigid phenolic material and generally come in 3 sizes, short, medium and long.

GUIDE TO TIG WELDING



Before starting any welding activity ensure that you have suitable eye protection and protective clothing. Also take the necessary steps to protect any persons within the welding area.

TIG welding electrodes

TIG welding electrodes are a 'non consumable' as it is not melted into the weld pool and great care should be taken not to let the electrode contact the welding pool to avoid weld contamination. This would be referred to as tungsten inclusion and may result in weld failure.

Electrodes will often contain small quantities of metallic oxides which can offer the following benefits:

- Assist in arc starting
- Improve current carrying capacity of the electrode
- Reduce the risk of weld contamination
- Increase electrode life
- Increase arc stability

Oxides used are primarily zirconium, thorium, lanthanum or cerium. These are added usually 1% - 4%.



Tungsten Electrode Colour Chart - DC

Welding Mode	Tungsten Type	Colour
DC or AC/DC	Ceriated 2%	Grey
DC or AC/DC	Lanthanated 1%	Black
DC or AC/DC	Lanthanated 1.5%	Gold
DC or AC/DC	Lanthanated 2%	Blue
DC	Thoriated 1%	Yellow
DC	Thoriated 2%	Red

Tungsten Electrode Current Ranges

Tungsten Electrode Size	DC Current Amp
1.0mm	30 - 60
1.6mm	60 - 115
2.4mm	100 - 165
3.2mm	135 - 200
4.0mm	190 - 280
4.8mm	250 - 340

Tungsten electrode preparation - DC

When welding at low current the electrode can be ground to a point.

At higher current a small flat on the end of the electrode is preferable as this helps with arc stability.

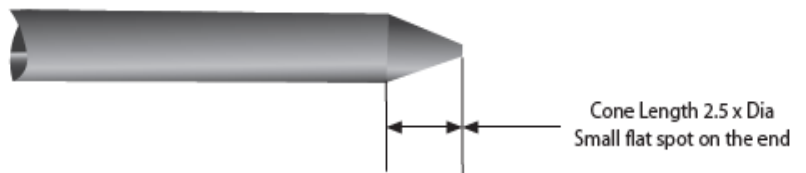

On inverter controlled AC & DC machines use tungsten electrode with cone length around 2.5 times the tungsten diameter

Electrode grinding

It is important when grinding the electrode to take all necessary precautions such as wearing eye protection and ensuring adequate protection against breathing in any grinding dust.

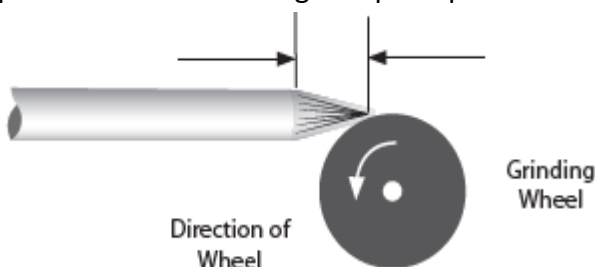

Tungsten electrodes should always be ground lengthwise (as shown) and not in a radial operation. Electrodes ground in a radial operation tend to contribute to arc wander due to the arc transfer from the grinding pattern. Always use a grinder solely for grinding electrodes to avoid contamination.

GUIDE TO TIG WELDING



Before starting any welding activity ensure that you have suitable eye protection and protective clothing. Also take the necessary steps to protect any persons within the welding area.

TIG welding consumables

The consumables of the TIG welding process are filler wires and shield gas.

Filler wires

Filler wires come in many different material types and usually as cut lengths, unless some automated feeding is required where it will be in reel form. Filler wire is generally fed in by hand. Always consult the manufacturer's data and welding requirements.

Filler Wire Diameter	DC Current Range (Amps)
1.0mm	20-90
2.4mm	65-115
3.2mm	100-165
4.8mm	200-350

Filler Wire Selection Guide

Gases

Shielding gas is required when welding to keep the weld pool free of oxygen. Whether you are welding mild steel or stainless steel the most commonly used shielding gas used in TIG welding is argon, for more specialised applications an argon helium mix or pure helium may be used.

TIG welding - arc starting

The TIG process can use both non contact and contact methods to provide arc starting. Depending on the Jasic model, the options are indicated on a selector switch on the front control panel of the power source. The most common method of arc starting is 'HF' start. This term is often used for a variety of starting methods and covers many different types of start.

Arc starting - scratch start

This system is where the electrode is scratched along the work piece like striking a match. This is a basic way of turning any DC stick welder into a TIG welder without much work. It is not considered suitable for high integrity welding due to the fact that the tungsten can be melted on the work piece thereby contaminating the weld.

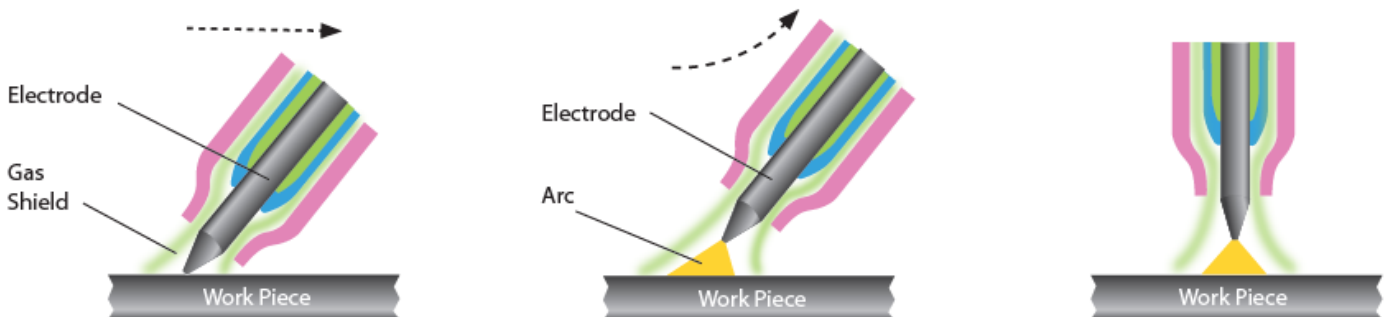

The main challenge with scratch start TIG welding is keeping your electrode clean. While a quick strike with the electrode on the metal is essential and then not lifting it more than 3mm away to create the arc will help, you also need to ensure your metal is completely clean.

GUIDE TO TIG WELDING



Before starting any welding activity ensure that you have suitable eye protection and protective clothing. Also take the necessary steps to protect any persons within the welding area.

Lift TIG (lift arc)

Not to be confused with scratch start, this arc starting method allows the tungsten to be in direct contact with the work piece first but with minimal current so as not to leave a tungsten deposit when the tungsten is lifted and an arc is established.

With lift TIG, the open circuit voltage (OCV) of the welder folds back to a very low voltage output when the unit senses it has made continuity with the work piece. Once the torch is lifted the unit increases output as the tungsten leaves the surface. This creates little contamination and preserves the point on the tungsten although this is still not a 100% clean process. The tungsten still can get contaminated but lift TIG is still a much better option than scratch starting, for mild and stainless steel although these methods of arc starting are not a good option when welding aluminium.

The Jasic TIG200 and TIG200P Lift TIG mode utilises the TIG torch switch operation mode which starts the process with the internal gas valve opening to start the gas flow first.

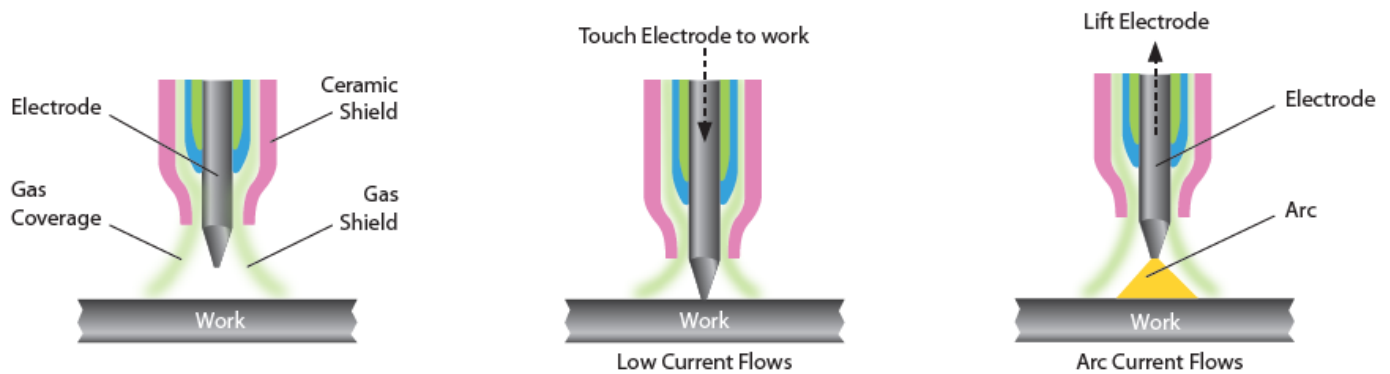

Set the TIG welding current and other TIG welding parameters by using the control dial. (see page 38 onwards for further details)

LIFT TIG process

Press the TIG torch switch, then touch the tungsten electrode to the work piece for less than 2 seconds and then lift away to 2-4mm from the work piece and the welding arc is then established.

Once welding is complete release the torch trigger to disengage the welding arc but ensure you leave the torch in place to shield the weld with gas for a few seconds and then turn off the gas at the valve on the torch head.

PLEASE NOTE:

- When starting the arc if the short-circuit time exceeds 2 seconds the welder turns off the output current, lift the welding torch tungsten away from the work piece and restart the process as above to start the arc again.
- During welding, if there is short circuit between tungsten electrode and the work piece, the welder will immediately reduce the output current; if the short circuit exceeds 1 second, the welder will turn off the output current. If this happens, the arc will need to be restarted as above and the welding torch needs to be lifted to start the arc again.

GUIDE TO TIG WELDING



Before starting any welding activity ensure that you have suitable eye protection and protective clothing. Also take the necessary steps to protect any persons within the welding area.

Arc starting - HF start

Non contact High Frequency (HF) start method is a high voltage and low amperage generated using a spark gap assembly and is the most popular and generally considered best TIG arc starting method. The High Frequency (HF) start generates a high frequency arc that ionizes the gas bridging the gap between the tungsten point and the work piece. This touchless method creates almost no contamination unless the tungsten has been over sharpened or the start amperage is too high. It is an excellent choice for all material being welded especially aluminium although.

The HF frequency varies with the spark gap and can be around 16000 Hz to 100000 Hz depending on spark gap width so consideration should be given with this method as it can cause electrical interference to nearby electrical equipment such as computers, CNC controls and phone systems.

If the spark gap is widened, the HF can become erratic.

DC TIG welding

Direct current welding is when the current flows in one direction only. Compared with AC welding the current once flowing will not go to zero until welding has ended.

The TIG torch polarity should generally be set up for Direct Current - Electrode Negative (DCEN), this method of welding can be used for a wide range of materials. The TIG welding torch is connected to the negative output of the machine and the work return cable to the positive output.

When the arc is established the current flows in the circuit and the heat distribution in the arc is around 33% in the negative side of the arc (the welding torch) and 67% in the positive side of the arc (the work piece). This balance gives deep arc penetration of the arc into the work piece and reduces heat in the electrode. This reduced heat in the electrode allows more current to be carried by smaller electrodes compared to other polarity connections. This starting method is often referred to as straight polarity and is the most common connection used in DC welding.

TIG welding techniques

- Before welding you should ensure all material being welded are clean, as particulates can weaken the weld.
- The torch angle is best kept at 15 ~ 20° (from vertical) away from the direction of travel. This assists with visibility of the weld area and allows easier access for the filler material.
- The filler metal should be fed in at a low angle to help avoid touching the tungsten electrode.
- The TIG welding arc melts the base material and the molten puddle melts the filler rod, it's important you resist the urge to melt the filler material directly into the welding arc.
- For thinner sheet materials, a filler material may not be needed.
- Prepare the tungsten correctly, using a diamond grinding wheel will give you the best results for a sharp point (see page 54).
- For welding stainless steel, be careful of applying too much heat. If the colour is dark grey and looks dirty and heavily oxidized then too much heat has been applied, this could also cause the material to warp. Reducing the amperage and increase travel speed may correct this problem, you could also consider using a smaller diameter filler material, as that will require less energy to melt.

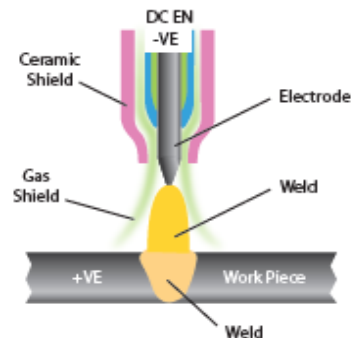
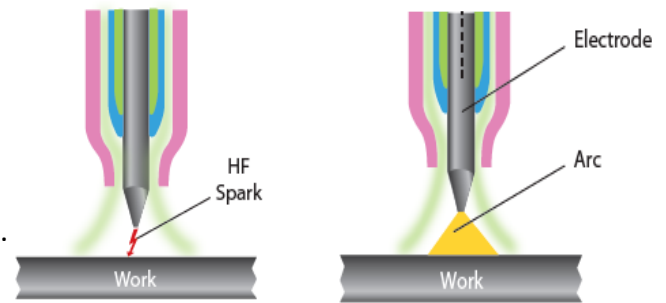

See the following page for a TIG DC welding amperage guide

GUIDE TO TIG WELDING



Before starting any welding activity ensure that you have suitable eye protection and protective clothing. Also take the necessary steps to protect any persons within the welding area.

Manual DC TIG Welding Amperage Guide- Mild Steel and Stainless Steel

Base Metal Thickness mm	Base Metal Thickness Inch	Tungsten Electrode Diameter	Output Polarity	Filler Wire Diameter (If Required)	Argon Gas Flow Rate (Litres/Min)	Joint Types	Amperage Range
1.6mm	1/16"	1.6mm	DC	1.6mm	5 - 8	Butt	50 - 80
1.6mm	1/16"	1.6mm	DC	1.6mm	5 - 8	Corner	50 - 80
1.6mm	1/16"	1.6mm	DC	1.6mm	5 - 8	Fillet	60 - 90
1.6mm	1/16"	1.6mm	DC	1.6mm	5 - 8	Lap	60 - 90
2.4mm	3/32"	1.6/2.4mm	DC	1.6/2.4mm	5 - 9	Butt	80 - 110
2.4mm	3/32"	1.6/2.4mm	DC	1.6/2.4mm	5 - 9	Corner	80 - 110
2.4mm	3/32"	1.6/2.4mm	DC	1.6/2.4mm	5 - 9	Fillet	90 - 120
2.4mm	3/32"	1.6/2.4mm	DC	1.6/2.4mm	5 - 9	Lap	90 - 120
3.2mm	1/8"	2.4mm	DC	2.4mm	5 - 10	Butt	80 - 120
3.2mm	1/8"	2.4mm	DC	2.4mm	5 - 10	Corner	90 - 120
3.2mm	1/8"	2.4mm	DC	2.4mm	5 - 10	Fillet	100 - 140
3.2mm	1/8"	2.4mm	DC	2.4mm	5 - 10	Lap	100 - 140
4.8mm	3/16"	2.4mm	DC	2.4mm	6 - 11	Butt	120 - 200
4.8mm	3/16"	2.4mm	DC	2.4mm	6 - 11	Corner	150 - 200
4.8mm	3/16"	2.4mm	DC	2.4mm	6 - 11	Fillet	170 - 220
4.8mm	3/16"	2.4mm	DC	2.4mm	6 - 11	Lap	150 - 200
6.4mm	1/4"	2.4mm	DC	3.2mm	7 - 12	Butt	225 - 300
6.4mm	1/4"	2.4mm	DC	3.2mm	7 - 12	Corner	250 - 300
6.4mm	1/4"	2.4mm	DC	3.2mm	7 - 12	Fillet	250 - 320
6.4mm	1/4"	2.4mm	DC	3.2mm	7 - 12	Lap	250 - 320
9.5mm	3/8"	3.2mm	DC	3.2mm	7 - 12	Butt	250 - 360
9.5mm	3/8"	3.2mm	DC	3.2mm	7 - 12	Corner	260 - 360
9.5mm	3/8"	3.2mm	DC	3.2mm	7 - 12	Fillet	270 - 380
9.5mm	3/8"	3.2mm	DC	3.2mm	7 - 12	Lap	230 - 380
12.7mm	1/2"	3.2/4mm	DC	3.2mm	8 - 13	Butt	300 - 400
12.7mm	1/2"	3.2/4mm	DC	3.2mm	8 - 13	Corner	320 - 420
12.7mm	1/2"	3.2/4mm	DC	3.2mm	8 - 13	Fillet	320 - 420
12.7mm	1/2"	3.2/4mm	DC	3.2mm	8 - 13	Lap	320 - 420

Please Note:

- All above guide settings are approximate and will vary depending on application, prep, required passes and type of welding equipment used.
- The welds would need to be tested to ensure they comply to your welding specifications.

GUIDE TO TIG WELDING



Before starting any welding activity ensure that you have suitable eye protection and protective clothing. Also take the necessary steps to protect any persons within the welding area.

AC TIG welding

Alternating current, AC welding, is when the current once flowing will not go to zero until welding has ended, compared with DC welding when the current flows in one direction only.

The Jasic TIG series polarity should generally be set up like Direct Current - Electrode Negative (DCEN) as this method of welding can be used for a wide range of materials.

The TIG welding torch is connected to the negative output of the machine and the work return cable to the positive output.

When the arc is established the current supplied by the machine operates with either positive and negative elements of half cycles. This means current flows one way and then the other at different times so the term alternating current is used. The combination of one positive element and one negative element is termed one cycle.

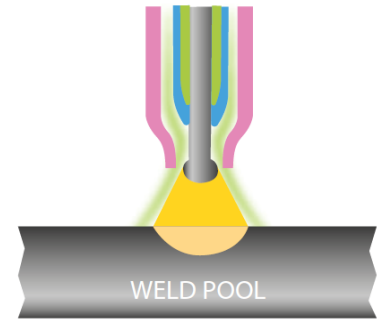

The number of times a cycle is completed within one second is referred to as the frequency. In the UK the frequency of alternating current supplied by the mains network is 50 cycles per second and is denoted as 50 Hertz (Hz).

This would mean that the current changes 100 times each second. The number of cycles per second (frequency) in a standard machine is dictated by the mains frequency which in the UK is 50Hz.

It is worth noting that as frequency increases magnetic effects increase and items such as transformers become increasingly more efficient. Also increasing the frequency of the welding current stiffens the arc, improves arc stability and leads to a more controllable welding condition.

However, this is theoretical as when welding in the TIG mode there are other influences on the arc.

The AC sine wave can be affected by the oxide coating of some materials which acts as a rectifier restricting the electron flow. This is known as arc rectification and its effect causes the positive half cycle to be clipped off or distorted.

The effect for the weld zone is erratic arc conditions, lack of cleaning action and possible tungsten damage.

See following page for the TIG AC welding amperage guide

GUIDE TO TIG WELDING



Before starting any welding activity ensure that you have suitable eye protection and protective clothing. Also take the necessary steps to protect any persons within the welding area.

Manual AC TIG Welding Amperage Guide - Aluminium Material

Base Metal Thickness mm	Base Metal Thickness Inch	Tungsten Electrode Diameter	Output Polarity	Filler Wire Diameter (If Required)	Argon Gas Flow Rate (Litres/Min)	Joint Types	Amperage Range Guide
1.6mm	1/16"	1.6mm	AC	1.6mm	6 - 9	Butt	65—75
1.6mm	1/16"	1.6mm	AC	1.6mm	6 - 9	Corner	55—65
1.6mm	1/16"	1.6mm	AC	1.6mm	6 - 9	Fillet	55—75
1.6mm	1/16"	1.6mm	AC	1.6mm	6 - 9	Lap	60—70
2.4mm	3/32"	1.6/2.4mm	AC	1.6/2.4mm	8 - 10	Butt	80—110
2.4mm	3/32"	1.6/2.4mm	AC	1.6/2.4mm	8 - 10	Corner	80—110
2.4mm	3/32"	1.6/2.4mm	AC	1.6/2.4mm	8 - 10	Fillet	90—130
2.4mm	3/32"	1.6/2.4mm	AC	1.6/2.4mm	8 - 10	Lap	95—130
3.2mm	1/8"	2.4mm	AC	2.4mm	8 - 11	Butt	115—135
3.2mm	1/8"	2.4mm	AC	2.4mm	8 - 11	Corner	90—120
3.2mm	1/8"	2.4mm	AC	2.4mm	8 - 11	Fillet	100—140
3.2mm	1/8"	2.4mm	AC	2.4mm	8 - 11	Lap	105—130
4.8mm	3/16"	2.4mm	AC	2.4mm	9 - 12	Butt	125—150
4.8mm	3/16"	2.4mm	AC	2.4mm	9 - 12	Corner	130—160
4.8mm	3/16"	2.4mm	AC	2.4mm	9 - 12	Fillet	150—180
4.8mm	3/16"	2.4mm	AC	2.4mm	9 - 12	Lap	130—170
6.4mm	1/4"	2.4mm	AC	2.4mm	11 - 14	Butt	190—220
6.4mm	1/4"	2.4mm	AC	2.4mm	11 - 14	Corner	140—170
6.4mm	1/4"	2.4mm	AC	2.4mm	11 - 14	Fillet	170—190
6.4mm	1/4"	2.4mm	AC	2.4mm	11 - 14	Lap	160—180
9.5mm	3/8"	3.2mm	AC	3.2mm	12 - 15	Butt	110—260
9.5mm	3/8"	3.2mm	AC	3.2mm	12 - 15	Corner	130—260
9.5mm	3/8"	3.2mm	AC	3.2mm	12 - 15	Fillet	240—270
9.5mm	3/8"	3.2mm	AC	3.2mm	12 - 15	Lap	230—250
12.7mm	1/2"	3.2/4mm	AC	3.2mm	13 - 16	Butt	120—290
12.7mm	1/2"	3.2/4mm	AC	3.2mm	13 - 16	Corner	145—300
12.7mm	1/2"	3.2/4mm	AC	3.2mm	13 - 16	Fillet	320—350
12.7mm	1/2"	3.2/4mm	AC	3.2mm	13 - 16	Lap	280—320

Please Note:

- All above guide settings are approximate and will vary depending on application, prep, passes and type of welding equipment used.
- The welds would need to be tested to ensure they comply to your welding specifications.

GUIDE TO TIG WELDING



Before starting any welding activity ensure that you have suitable eye protection and protective clothing. Also take the necessary steps to protect any persons within the welding area.

AC TIG welding square wave

With the electronic development of inverter power sources, the square wave machine was developed. Due to these electronic controls the cross over from positive to negative and vice versa can be made almost in an instant which leads to more effective current in each half cycle due to a longer period at maximum. The effective use of the magnetic field energy stored creates waveforms which are very near square.

The ET-200PACDC square wave machine allows us control of the positive (cleaning) and negative (penetration) half cycles.

The balance condition with equal positive and negative half cycles will give a stable weld condition. The problems that can be encountered are that once cleaning has occurred in less than the positive half cycle time then some of the positive half cycle is not productive and can also increase potential damage to the electrode due to overheating.

However, this can be eliminated by the use of balance control which allows the time of the positive half cycle to be varied within the cycle time.

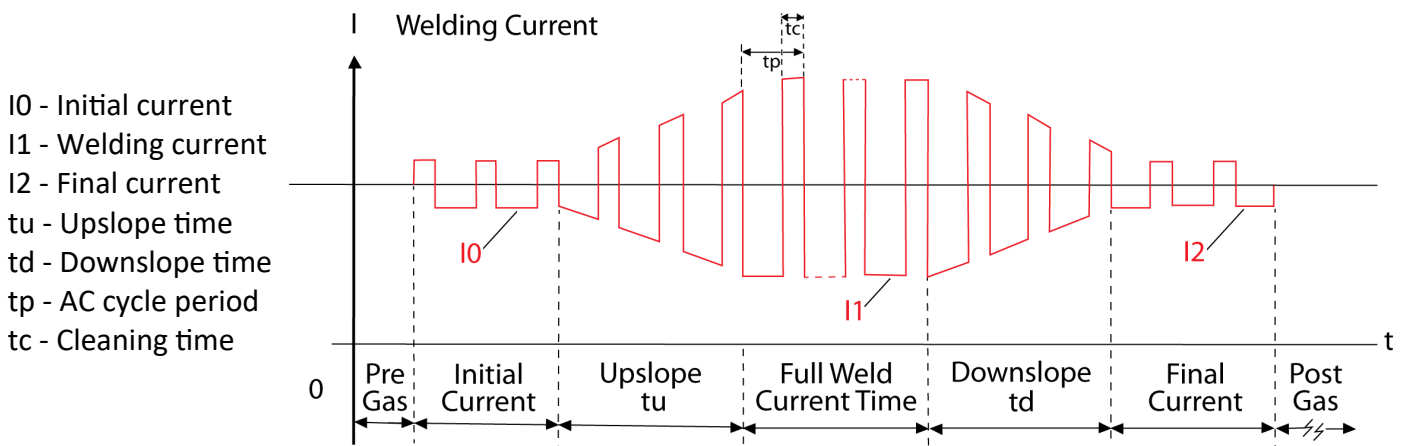
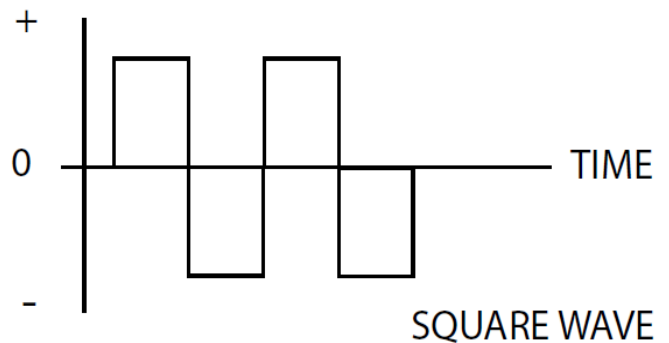

In AC square wave TIG welding, the pre flow time and post flow time are the same as in DC TIG welding. Others parameters are described below:

Initial current (I_0), welding current (I_1) and pilot arc current (I_2).

The preset value of the three parameters is approximately the absolute average of the practical welding current and can be adjusted according to users technical requirements.

Pulse frequency ($1/tp$): It can be adjusted according to users technical requirements.

Cleaning strength ($100\% * Tc/tp$): Generally, in AC welding when taking the electrode as the anode, the current is called the cathode current. Its main function is to break up the oxidized layer of the work piece and the cleaning strength is the percentage cathode current holding in the AC period.

This parameter is 10 ~ 40% commonly. When the value is smaller the arc is concentrated and the molten pool is narrow and deep although when the value is larger, the arc is spread, the molten pool is wide and shallow.

GUIDE TO TIG WELDING



Before starting any welding activity ensure that you have suitable eye protection and protective clothing. Also take the necessary steps to protect any persons within the welding area.

AC pulsed TIG welding

Tc - Cleaning time

Tp - AC period

Tp - Pulsed peak current time

T - Pulse period

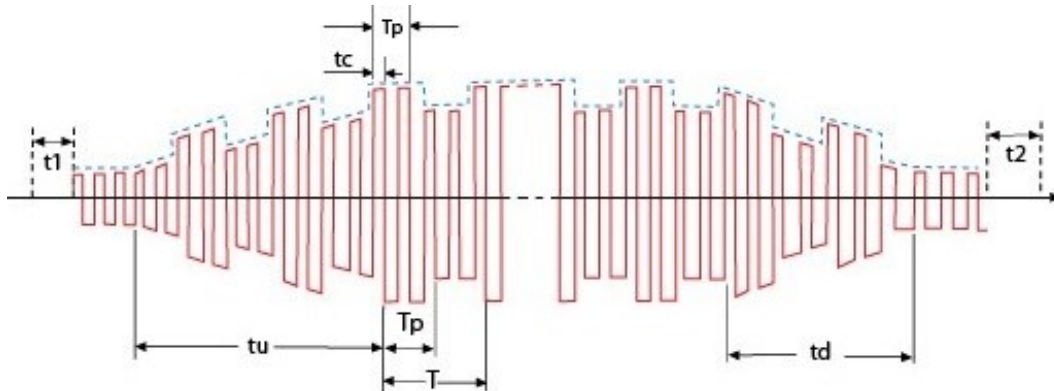

AC pulsed TIG welding is almost the same as AC square wave TIG welding and what makes them different is that in AC pulsed TIG welding the welding current varies with the pulse peak current and base current. For the AC square wave parameter selecting and setting, please refer to the corresponding contents in AC square wave TIG welding. For the pulse frequency and pulse duration ratio users may refer to the corresponding contents in DC pulsed TIG welding.

The pulse frequency ($1/T$) can be adjusted between 0.2Hz and 5Hz. The pulse duration ratio (T_p/T) can be adjusted between 10% and 90%.

AC frequency

The normal mains frequency of equipment is 50Hz. However, this ET-200PACDC has an output adjustment range of between 20 ~ 250Hz.

With TIG welding power supplies that have an adjustable AC frequency, lowering the AC frequency would provide a softer, less forceful wide arc which offers a wider bead with shallow penetration.

AC Frequency
Low Frequency

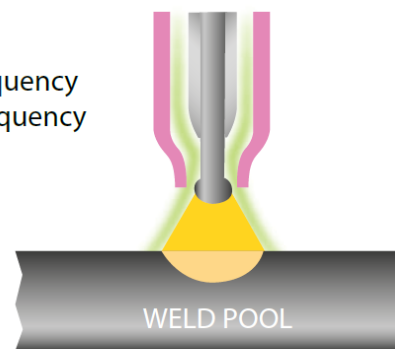

Soft Arc with Shallow Penetration

Increasing the AC frequency has the effect of concentrating the arc making it easily directional with narrower bead with deeper penetration.

AC Frequency
High Frequency

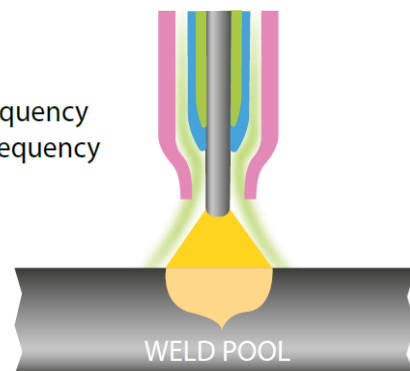

Tighter Arc with Deeper Penetration

GUIDE TO TIG WELDING



Before starting any welding activity ensure that you have suitable eye protection and protective clothing. Also take the necessary steps to protect any persons within the welding area.

AC Wave balance or cleaning control

When welding materials with a refractory oxide surface such as aluminium this oxide needs to be removed to allow welding of the base material. In the AC mode the oxide is removed during the positive half of the AC wave. This control allows the user to set the amount of time between positive and negative which is represented by moving A or B in the image right.

The higher the setting the more aggressive the cleaning action but more time in the positive cycle drives more energy into the tungsten so care should be taken to avoid overheating the tungsten. AC balance zero is normally 50% positive and 50% negative.

Please Note:

For the ET-200PACDC the factor set balanced 'zero' point is represented as 40 on the digital display and the range of balance varies between 20 ~ 60.

With the correct setting of the frequency and balance controls it is possible to use a smaller size tungsten.

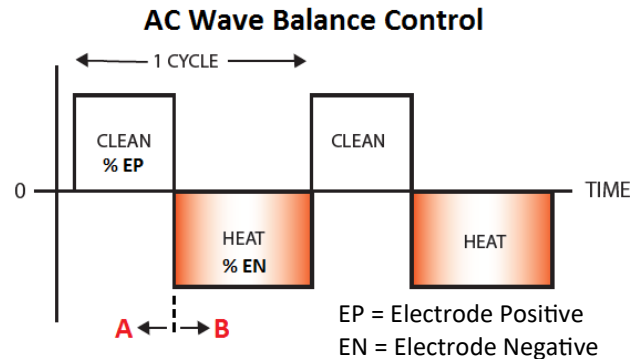

Maximum penetration

This can be achieved by placing the control to a position which will enable more time to be spent in the negative half cycle with respect to the positive half cycle. This will allow for higher current to be used with smaller electrodes as more of the heat is in the positive (work). The increase in heat also results in deeper penetration when welding at the same travel speed as the balanced condition, a reduced heat affected zone and less distortion due to the narrower arc.

Please Note:

To obtain more penetration for the ET-200PACDC, the AC balance adjustment range is represented between 20 ~ 40.

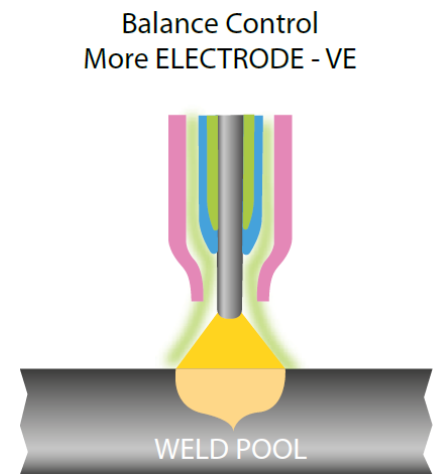

Maximum cleaning

This can be achieved by placing the control to a position which will enable more time to be spent in the positive half cycle with respect to the negative half cycle. This will allow for very active cleaning current to be used. It should be noted that there is an optimum cleaning time after which more cleaning will not occur and the potential of damage to the electrode is greater. The effect on the arc is to provide a wider clean weld pool with shallow penetration.

Please Note:

To obtain more cleaning for the ET-200PACDC, the AC balance adjustment range is represented between 40 ~ 60.

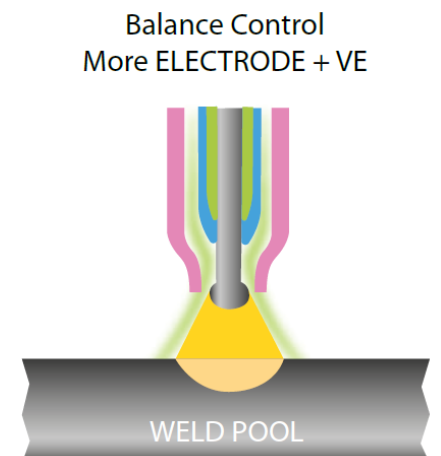

TIG TORCH SPARE PARTS LIST



TIG Welding Torch Air Cooled - Model JE79-ERGO (Type WP26)

Rating 200A DC, 150A AC @ 60% Duty Cycle EN60974-7 • 0.5mm to 4mm Electrodes



9 PIN Torch plug Pt No - JSG-PLUG-9PIN

Consumables

Model: T26

Main Consumables

Code	Description	Pack Qty
1	WP26 Rigid Torch Body	1
2	WP26F Flexible Torch Body	1
3	WP26FV Flexible Torch Body c/w Argon Valve	1
4	WP26V Torch Body c/w Argon Valve	1
5	57Y04 Short Back Cap	1
6	300M Medium Back Cap	1
7	57Y02 Long Back Cap	1
8	98W18 Back Cap O' Ring	10

Collets

9	10N21 Standard .020" (0.5mm)	5
	10N22 Standard .040" (1.0mm)	5
	10N23 Standard 1/16" (1.6mm)	5
	10N26 Standard 5/64" (2.0mm)	5
	10N24 Standard 3/32" (2.4mm)	5
	10N25 Standard 1/8" (3.2mm)	5
	54N20 Standard 5/32" (4.0mm)	5
10	10N21S Stubby .020" (0.5mm)	5
	10N22S Stubby .040" (1.0mm)	5
	10N23S Stubby 1/16" (1.6mm)	5
	10N24S Stubby 3/32" (2.4mm)	5
	10N25S Stubby 1/8" (3.2mm)	5

Collet Bodies

11	10N29 Standard .020" (0.5mm)	5
	10N30 Standard .040" (1.0mm)	5
	10N31 Standard 1/16" (1.6mm)	5
	10N31M Standard 5/64" (2.0mm)	5
	10N32 Standard 3/32" (2.4mm)	5
	10N28 Standard 1/8" (3.2mm)	5
	406488 Standard 5/32" (4.0mm)	5
12	17CB20 Stubby .020" - 1/8" (0.5 - 3.2mm)	5

Gas Lens Bodies

13	45V29 Standard .020" (0.5mm)	1
	45V24 Standard .040" (1.0mm)	1
	45V25 Standard 1/16" (1.6mm)	1
	45V25M Standard 5/64" (2.0mm)	1
	45V26 Standard 3/32" (2.4mm)	1
	45V27 Standard 1/8" (3.2mm)	1
	45V28 Standard 5/32" (4.0mm)	1
14	45V0204 Large Dia .020"-.040" (0.5 - 1.0mm)	1
	45V116 Large Dia 1/16" (1.6mm)	1
	45V64 Large Dia 3/32" (2.4mm)	1
	995795 Large Dia 1/8" (3.2mm)	1
	45V63 Large Dia 5/32" (4.0mm)	1

Ceramic Cups

15	10N50 Standard Cup 1/4" Bore	10
	10N49 Standard Cup 5/16" Bore	10
	10N48 Standard Cup 3/8" Bore	10
	10N47 Standard Cup 7/16" Bore	10
	10N46 Standard Cup 1/2" Bore	10
	10N45 Standard Cup 5/8" Bore	10
	10N44 Standard Cup 3/4" Bore	10

Ceramic Cups (continued)

Code	Description	Pack Qty
16	10N50L Long Cup 1/4" Bore	10
	10N49L Long Cup 5/16" Bore	10
	10N48L Long Cup 3/8" Bore	10
	10N47L Long Cup 7/16" Bore	10

Gas Lens Cups

17	54N18 Standard Cup 1/4" Bore	10
	54N17 Standard Cup 5/16" Bore	10
	54N16 Standard Cup 3/8" Bore	10
	54N15 Standard Cup 7/16" Bore	10
	54N14 Standard Cup 1/2" Bore	10
	54N19 Standard Cup 11/16" Bore	10
18	54N17L Long Cup 5/16" Bore	10
	54N16L Long Cup 3/8" Bore	10
	54N15L Long Cup 7/16" Bore	10
	54N14L Long Cup 1/2" Bore	10
19	57N75 Large Dia Cup 3/8" Bore	5
	57N74 Large Dia Cup 1/2" Bore	5
	53N88 Large Dia Cup 5/8" Bore	5
	53N87 Large Dia Cup 3/4" Bore	5

Ceramic Cups for use with item 12

20	13N08 Standard Cup 1/4" Bore	10
	13N09 Standard Cup 5/16" Bore	10
	13N10 Standard Cup 3/8" Bore	10
	13N11 Standard Cup 7/16" Bore	10
	13N12 Standard Cup 1/2" Bore	10
	13N13 Standard Cup 5/8" Bore	10
21	796F70 Long Cup 3/16" Bore	10
	796F71 Long Cup 1/4" Bore	10
	796F72 Long Cup 5/16" Bore	10
	796F73 Long Cup 3/8" Bore	10
22	796F74 X - Long Cup 3/16" Bore	10
	796F75 X - Long Cup 1/4" Bore	10
	796F76 X - Long Cup 5/16" Bore	10
	796F77 X - Long Cup 3/8" Bore	10

Secondary Consumables

23	TBC LH & RH Handle Shell	1
24	SP9111 Handle Screw	1
25	SP9120 Single Button Switch	1
	SP9121 2 Button Switch	1
	SP9122 5K Potentiometer Switch	1
	SP9123 10K Potentiometer Switch	1
	SP9128 47K Potentiometer Switch	1
	SP9129 4 Button Switch	1
26	SP9114 Handle Ball Joint	1
27	SP9117 Leather Cover 800mm	1
28	SP9119 Cable Cover Joint (not illustrated)	1
29	18CC Standard Heat Shield	1
30	54N01 Gas Lens Heat Shield	1
31	54N63 Large Gas Lens Insulator	1
32	VS-1 Valve Stem WP26V & WP26FV	1
33	46V28 Mono Power Cable Assy 12.5ft - 3/8" Bsp	1
	46V30 Mono Power Cable Assy 25ft - 3/8" Bsp	1
34	46V28-2D 2 Piece Power Cable Assy 12.5ft - Dinse / 3/8" Bsp	1
	46V30-2D 2 Piece Power Cable Assy 25ft - Dinse / 3/8" Bsp	1
35	0315071 Insulation Boot	5
36	6091 Neoprene Protective Cover	1m
37	SP9126 4m Switch Cable c/w 5 Pin Receptacle	1
	SP9127 8m Switch Cable c/w 5 Pin Receptacle	1

TIG TORCH SPARE PARTS LIST



TIG Welding Torch Water Cooled - Model JE83-ERGO

Rating 350A DC, 260A AC @ 100% Duty Cycle EN60974-7 • 0.5mm to 4.0mm Electrodes

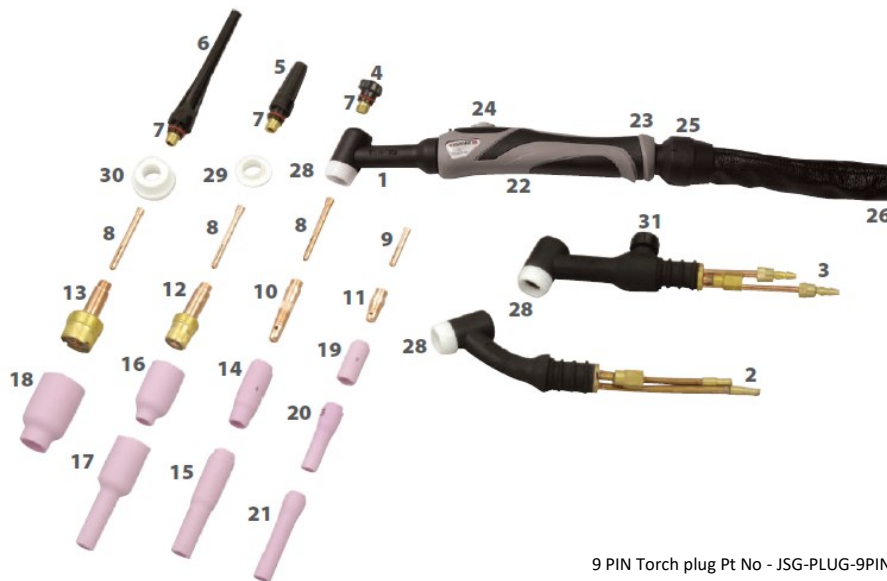

9 PIN Torch plug Pt No - JSG-PLUG-9PIN

Main Consumables

Code	Description	Pack Qty
1	WP18 Rigid Torch Body	1
2	WP18F Flexible Torch Body	1
3	WP18V Torch Body c/w Argon Valve	1
4	57Y04 Short Back Cap	1
5	300M Medium Back Cap	1
6	57Y02 Long Back Cap	1
7	98W18 Back Cap 'O' Ring	10

Collets

8	10N21 Standard .020" (0.5mm)	5
	10N22 Standard .040" (1.0mm)	5
	10N23 Standard 1/16" (1.6mm)	5
	10N26 Standard 5/64" (2.0mm)	5
	10N24 Standard 3/32" (2.4mm)	5
	10N25 Standard 1/8" (3.2mm)	5
	54N20 Standard 5/32" (4.0mm)	5
9	10N21S Stubby .020" (0.5mm)	5
	10N22S Stubby .040" (1.0mm)	5
	10N23S Stubby 1/16" (1.6mm)	5
	10N24S Stubby 3/32" (2.4mm)	5
	10N25S Stubby 1/8" (3.2mm)	5

Collet Bodies

10	10N29 Standard .020" (0.5mm)	5
	10N30 Standard .040" (1.0mm)	5
	10N31 Standard 1/16" (1.6mm)	5
	10N31M Standard 5/64" (2.0mm)	5
	10N32 Standard 3/32" (2.4mm)	5
	10N28 Standard 1/8" (3.2mm)	5
	406488 Standard 5/32" (4.0mm)	5
11	17CB20 Standard .020" - 1/8" (0.5 - 3.2mm)	5

Gas Lens Bodies

12	45V29 Standard .020" (0.5mm)	1
	45V24 Standard .040" (1.0mm)	1
	45V25 Standard 1/16" (1.6mm)	1
	45V25M Standard 5/64" (2.0mm)	1
	45V26 Standard 3/32" (2.4mm)	1
	45V27 Standard 1/8" (3.2mm)	1
	45V28 Standard 5/32" (4.0mm)	1
13	45V0204 Large Dia .020"-.040" (0.5 - 1.0mm)	1
	45V116 Large Dia 1/16" (1.6mm)	1
	45V64 Large Dia 3/32" (2.4mm)	1
	995795 Large Dia 1/8" (3.2mm)	1
	45V63 Large Dia 5/32" (4.0mm)	1

Ceramic Cups

14	10N50 Standard Cup 1/4" Bore	10
	10N49 Standard Cup 5/16" Bore	10
	10N48 Standard Cup 3/8" Bore	10
	10N47 Standard Cup 7/16" Bore	10
	10N46 Standard Cup 1/2" Bore	10
	10N45 Standard Cup 5/8" Bore	10
	10N44 Standard Cup 3/4" Bore	10
15	10N50L Long Cup 1/4" Bore	10
	10N49L Long Cup 5/16" Bore	10
	10N48L Long Cup 3/8" Bore	10
	10N47L Long Cup 7/16" Bore	10

Gas Lens Cups

Code	Description	Pack Qty
16	54N18 Standard Cup 1/4" Bore	10
	54N17 Standard Cup 5/16" Bore	10
	54N16 Standard Cup 3/8" Bore	10
	54N15 Standard Cup 7/16" Bore	10
	54N14 Standard Cup 1/2" Bore	10
	54N19 Standard Cup 11/16" Bore	10
17	54N17L Long Cup 5/16" Bore	10
	54N16L Long Cup 3/8" Bore	10
	54N15L Long Cup 7/16" Bore	10
	54N14L Long Cup 1/2" Bore	10
18	57N75 Large Dia Cup 3/8" Bore	5
	57N74 Large Dia Cup 1/2" Bore	5
	53N88 Large Dia Cup 5/8" Bore	5
	53N87 Large Dia Cup 3/4" Bore	5

Ceramic Cups for use with item 11

19	13N08 Standard Cup 1/4" Bore	10
	13N09 Standard Cup 5/16" Bore	10
	13N10 Standard Cup 3/8" Bore	10
	13N11 Standard Cup 7/16" Bore	10
	13N12 Standard Cup 1/2" Bore	10
	13N13 Standard Cup 5/8" Bore	10
20	796F70 Long Cup 3/16" Bore	10
	796F71 Long Cup 1/4" Bore	10
	796F72 Long Cup 5/16" Bore	10
	796F73 Long Cup 3/8" Bore	10
21	796F74 X - Long Cup 3/16" Bore	10
	796F75 X - Long Cup 1/4" Bore	10
	796F76 X - Long Cup 5/16" Bore	10
	796F77 X - Long Cup 3/8" Bore	10

Secondary Consumables

22	TBC LH & RH Handle Shell	1
23	SP9111 Handle Screw	1
24	SP9120 Single Button Switch	1
	SP9121 2 Button Switch	1
	SP9122 5K Potentiometer Switch	1
	SP9123 10K Potentiometer Switch	1
	SP9128 47K Potentiometer Switch	1
	SP9129 4 Button Switch	1
25	SP9114 Handle Ball Joint	1
26	SP9117 Leather Cover 800mm	1
27	SP9119 Cable Cover Joint (not illustrated)	1
28	18CG Standard Heat Shield	1
29	54N01 Gas Lens Heat Shield	1
30	54N63 Large Gas Lens Insulator	1
31	VS-1 Valve Stem WP18V	1
32	40V64 Power Cable Assy 12.5ft - 3/8" Bsp	1
	41V29 Power Cable Assy 25ft - 3/8" Bsp	1
33	45V07 Argon Hose Assy 12.5ft - 3/8" Bsp	1
	45V08 Argon Hose Assy 25ft - 3/8" Bsp	1
34	40V74 Water Hose Assy 12.5ft - 3/8" Bsp	1
	41V32 Water Hose Assy 25ft - 3/8" Bsp	1
35	0315071 Insulation Boot	5
36	6091 Neoprene Protective Cover	1m
37	SP9126 4m Switch Cable c/w 5 Pin Receptacle	1
	SP9127 8m Switch Cable c/w 5 Pin Receptacle	1

TIG WELDING TROUBLESHOOTING



Before starting any welding activity ensure that you have suitable eye protection and protective clothing. Also take the necessary steps to protect any persons within the welding area.

TIG welding defects and prevention methods

<u>Defect</u>	<u>Possible cause</u>	<u>Action</u>
Excessive tungsten use	Set up for DCEP	Change to DCEN
	Insufficient shield gas flow	Check for gas restriction and correct flow rates. Check for drafts in the weld area
	Electrode size too small	Select correct size
	Electrode contamination during cooling time	Extend post flow gas time
Porosity/weld contamination	Loose torch or hose fitting	Check and tighten all fitting
	Inadequate shield gas flow	Adjust flow rate - normally 8-12L/m
	Incorrect shield gas	Use correct shield gas
	Gas hose damaged	Check and repair any damaged hoses
	Base material contaminated	Clean material properly
	Incorrect filler material	Check correct filler wire for grade of use
No operation when torch switch is operated	Torch switch or cable faulty	Check the torch switch continuity and repair or replace as required
	ON/OFF switch turned off	Check position of ON/OFF switch
	Mains fuses blown	Check fuses and replace as required
	Fault inside the machine	Call for a repair technician
Low output current	Loose or defective work clamp	Tighten/replace clamp
	Loose cable plug	Check and tighten all plugs
	Power source faulty	Call a repair technician
High frequency will not strike the arc	Weld/power cable open circuit	Check all cables and connections for continuity, especially the torch cables
	No shield gas flowing	Check cylinder contents, regulator and valves, also check the power source
Unstable arc when welding in DC	Tungsten contaminated	Break off contaminated end and regrind the tungsten
	Arc length incorrect	Arc length should be between 3-6mm
	Material contaminated	Clean all base and filler material
	Electrode connected to the wrong polarity	Reconnect to correct polarity
Arc is difficult to start	Incorrect tungsten type	Check and fit correct tungsten
	Incorrect shield gas	Use argon shield gas

TIG WELDING TROUBLESHOOTING



Before starting any welding activity ensure that you have suitable eye protection and protective clothing. Also take the necessary steps to protect any persons within the welding area.

TIG welding defects and prevention methods

<u>Defect</u>	<u>Possible cause</u>	<u>Action</u>
Excessive bead build up, poor penetration or poor fusion at the edges of the weld	Weld current too low	Increase the welding amperage Poor material prep
Weld bead flat and too wide or undercut at the weld edge or burning through	Weld current too high	Decrease the welding amperage
Weld bead too small or insufficient penetration	Welding travel speed too fast	Reduce your welding travel speed
Weld bead too wide or excessive bead build up	Welding travel speed too slow	Increase your welding travel speed
Uneven leg length in fillet joint	Wrong placement of filler rod	Re-position filler rod
Tungsten melts or oxidises when welding arc is made	TIG torch lead connected to + Little or no gas flow to weld pool Gas cylinder or hoses contain impurities The tungsten is too small for the weld current TIG/MMA selector set to MMA	Connect to - polarity Check gas apparatus as well as torch and hoses for breaks or restrictions Change gas cylinder and blow out torch and gas hoses Increase the size of the tungsten Ensure you have the power source set to TIG function

TIG TORCH TROUBLESHOOTING

TIG welding defects and prevention methods

The TIG torch used for lift TIG welding comprises of several items which ensure current flow and arc shielding from the atmosphere.

Regular maintenance of the welding torch is one of the most important measures to ensure its normal operation and extend lifespan.

In order to ensure normal maintenance, the wearing parts of the torch should have spares, including the electrode holder, nozzle, sealing ring, insulating washer, etc.

Common faults of the welding torch include overheating, gas leakage, water leakage, poor gas protection, electric leakage, nozzle burn out, and cracking. The causes of these faults and troubleshooting methods are as shown in the following table:

Symptom	Reasons	Troubleshooting
The welding torch is overheating	The welding torch capacity is too small	Replace with a welding torch with large capacity
	The collet fails to clamp the tungsten electrode	Replace the collet or back cap
Gas leakage	The sealing ring is worn	Replace the sealing ring
	The gas connection thread is loose	Tighten it
	The gas inlet pipe joint is damaged or not fastened	Cut off the damaged joint, reconnect and tighten the replaced gas inlet pipe or wrap up the damaged area
	The gas inlet pipe has been damaged by heat or aging	Replace the gas inlet pipe
Operator receiving a shock from the torch	The torch head is wet due to leakage or other reasons	Find the cause of water leakage, and fully dry the torch head
	The torch head is damaged or the live metal part is exposed	Replace the torch head or wrap the exposed electrified metal part with adhesive tape
Poor gas flow or porosity in the weld	The welding torch is leaking	Locate the leakage
	The nozzle diameter is too small	Replace with a nozzle of larger diameter
	The nozzle is damaged or cracked	Replace with a new nozzle
	The gas circuit in the welding torch is blocked	Blow the circuit with compressed air to clear the blockage
	The gas screen has been damaged or lost during disassembly and assembly	Replace with a new gas screen
	The argon gas is impure	Replace with standard argon gas
	The gas flow is too large or small	Adjust the gas flow properly
Arc started between the collet/collet holder or the tungsten electrode/torch head	The collet and tungsten electrode have poor contact, or arc is started when the tungsten electrode contacts the base metal	Replace the collet or repair
	The collet and welding torch have poor contact	Connect the collet and welding torch properly

MAINTENANCE



The following operation requires sufficient professional knowledge on electric aspects and comprehensive safety knowledge. Make sure the input cable of the machine is disconnected from the electricity supply and wait for 5 minutes before removing the machine covers.

In order to guarantee that the arc welding machine works efficiently and in safety, it must be maintained regularly. Operators should understand the maintenance methods and means of arc welding machine operation. This guide should enable customers to carry out simple examination and safeguarding by oneself, try to reduce the fault rate and repair times of the arc welding machine, so as to lengthen service life of arc welding machines.

<u>Period</u>	<u>Maintenance item</u>
Daily examination	Check the condition of the machine, mains cables, welding cables and connections. Check for any warnings LEDs and machine operation.
Monthly examination	Disconnect from the mains supply and wait for at least 5 minutes before removing the cover. Check internal connections and tighten if required. Clean the inside of the machine with a soft brush and vacuum cleaner. Take care not to remove any cables or cause damage to components. Ensure that ventilation grills are clear. Carefully replace the covers and test the unit. This work should be carried out by a suitably qualified competent person.
Yearly examination	Carry out an annual service to include a safety check in accordance with the manufacturers standard (EN 60974-1). This work should be carried out by a suitably qualified competent person.

TROUBLESHOOTING

Before arc welding machines are dispatched from the factory, they have already been checked thoroughly. The machine should not be tampered with or altered. Maintenance must be carried out carefully. If any wire becomes loose or is misplaced, it maybe potentially dangerous to user!

Only professional maintenance personnel should repair the machine!

<u>Description of fault</u>	<u>Possible cause</u>	<u>Action</u>
The welding arc cannot be established	Power switch has not been switched ON Incoming mains power supply is not ON Possible internal power failure	- Switch ON power switch - Check incoming power switch for correct operation and supply - Have a technician check the machine and mains power supply
Difficult arc ignition	Low arc current	- Increase the arc current setting - Check condition of the MMA welding leads
Overheat LED lit	Machine operated outside duty cycle Fan not working	- Allow the machine to cool and the unit will reset automatically - Have a technician check for obstructions blocking the fan
Over current LED lit	Mains supply problem	- Have a technician check the mains supply

TROUBLESHOOTING - ERROR CODES



The following operation requires sufficient professional knowledge on electric aspects and comprehensive safety knowledge. Make sure the input cable of the machine is disconnected from the electricity supply and wait for 5 minutes before removing any machine covers.

The below is a list of error codes for the Jasic EVO ET200PACDC welding machine.

Error Code	Error Code Description	Possible Cause	Check
E10	Overcurrent protection	The output is at maximum capacity current of machine	Turn the machine off and back on again. If overcurrent protection alarm is still active, contact your suppliers approved technician.
E31	Undervoltage protection	The input mains voltage is too low	Turn the machine off and back on again. If the alarm continues, check the input voltage. If the input voltage is within specification and the alarm persists, contact your suppliers approved technician.
E32	Overvoltage protection	The input mains voltage is too high	Turn the machine off and back on again. If the alarm continues, check the input voltage. If the input voltage is within specification and the alarm persists, contact your suppliers approved technician.
E34	Undervoltage protection	Under voltage in inverter circuit	Turn the machine off and back on again. If the alarm continues, check the input voltage. If the input voltage is within specification and the alarm persists, contact your suppliers approved technician.
E60	Overheating	An over temperature signal received from the output rectifier circuit	Do not turn off the machine, wait for a while and after the thermal error goes off then you can continue welding. While error code is ON, machine cannot cut. Ensure cooling fans are operational. Decrease duty cycle welding activity.
E61	Overheating	An over temperature signal received from the Inverter IGBT circuit	Do not turn off the machine, wait for a while and after the thermal error goes off then you can continue welding. While error code is ON, machine cannot cut. Ensure cooling fans are operational. Decrease duty cycle welding activity.
E71	Water cooler alarm	Lack of water flow	Turn off and restart the machine. Check coolant level in tank, check flow and also check for blockage. If the alarm cannot be eliminated, contact your maintenance personnel.
	Abnormal VRD	VRD voltage is too high or too low	Turn the machine off and back on again. If the fault VRD alarm persists, contact your suppliers approved technician.

Please Note:

If you have checked over the fault and the alarm condition still persists then contact your suppliers approved technician.

WEEE disposal

The equipment is manufactured with materials which do not contain any toxic or poisonous materials dangerous to the operator.

When the equipment is scrapped, it should be dismantled separating components according to the type of materials.

Do not dispose of the equipment with normal waste. The European Directive 2002/96/EC and United Kingdom's Directive The Waste Electrical and Electronic Equipment (WEEE) regulations 2013 states that electrical equipment that has reached its end of life must be collected separately and returned to an environmentally compatible recycling facility.

Jasic has a relevant recycling system which is compliant and registered in the UK with the environment agency. Our registration reference is WEEMM3813AA.

In order to comply with WEEE regulations outside the UK you should contact your supplier.

RoHS Compliance Declaration

We herewith confirm, that the above mentioned product does not contain any of the restricted substances as listed in EU Directive 2011/65/EU and the UK directive ROHS Regulations 2012 in concentrations above the limits as specified therein.

Disclaimer:

Please note that this confirmation is given to the best of our present knowledge and belief.

Nothing herein represents and/or may be interpreted as warranty within the meaning of the applicable warranty law.

UKCA Declaration of Conformity



UK DECLARATION OF CONFORMITY

The manufacturer or its legal representative Wilkinson Star Limited declares that the equipment listed described below is designed and produced according to the following UK directives:

Electrical equipment (Safety) regulations 2016	2016 No 1101
Electromagnetic compatibility regulations 2016	2016 No 1091
The restriction of the use of certain hazardous substances in electrical and electronic equipment	2012 No 3052
Requirements for welding equipment pursuant to the eco-design for energy related products and energy information regulations 2021	UK SI 2021/745

And inspected in compliance with the following harmonised standards

- BS EN 60974-1:2018 + A1:2019
- BS EN 60974-10:2014 + A1:2015
- BS EN 62822-1:2018
- BS EN 60974-3 2019

Any alteration or change to these machines by any unauthorised person makes this declaration invalid

WILKINSON STAR MODEL

- ET 200
- ET 200P
- ET 200P ACDC

JASIC MODEL

- TIG 200 PFC W2S42
- TIG 200 P PFC W2S62
- TIG 200 P ACDC PFC E2S22

Authorised Representative

Wilkinson Star Limited
 Shield Drive, Wardley Industrial Estate
 Worsley, Salford M28 2WD
 Tel +44 161 793 8127

Signature:

Dr John A Wilkinson OBE

Position: Chairman

Date:



Manufacturer

Shenzhen Jasic Technology Co Ltd
 No3 Qinglan, 1st Road
 Pingshan District
 Shenzhen, China

Signature:

Shenzhen Jasic Technology Co Ltd

Position:

Date:

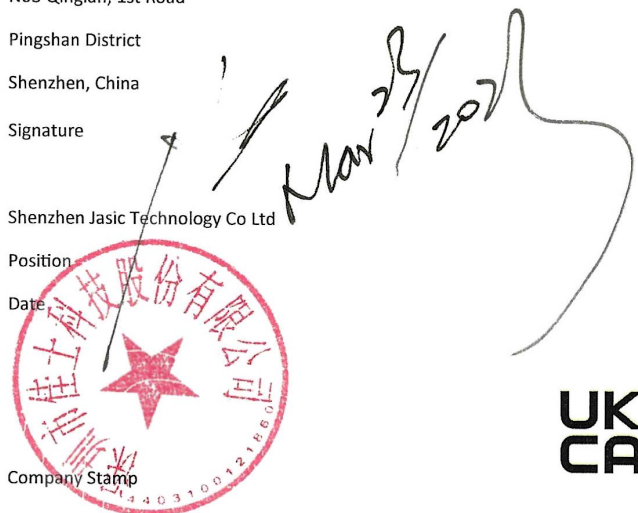

EC DECLARATION OF CONFORMITY



EU DECLARATION OF CONFORMITY

The manufacturer or its legal representative Wilkinson Star Limited declares that the equipment listed described below is designed and produced according to the following EU directives:

Low voltage directive (LVD)	2014/35/EU
Electromagnetic compatibility directive (EMC)	2014/30/EU
RoHS2	2011/65/EU
Annex 11 of RoHS2	2015/863
Eco design requirements for welding equipment pursuant 2009/125/EC	2019/1784

And inspected in compliance with the following harmonised standards

- EN 60974-1:2018 + A1:2019
- EN 60974-10:2014 + A1:2015
- EN 62822-1:2018
- EN 60974-3 2019

Any alteration or change to these machines by any unauthorised person makes this declaration invalid

WILKINSON STAR MODEL

- ET 200
- ET 200P
- ET 200P ACDC

JASIC MODEL

- TIG 200 PFC W2S42
- TIG 200 P PFC W2S62
- TIG 200 P ACDC PFC E2S22

Authorised Representative

Wilkinson Star Limited
Shield Drive, Wardley Industrial Estate
Worsley, Salford M28 2WD
Tel +44 161 793 8127

Signature

Dr John A. Wilkinson OBE

Position Chairman

Date 05/18/2021



Company stamp

Manufacturer

Shenzhen Jasic Technology Co Ltd
No3 Qinglan, 1st Road
Pingshan District
Shenzhen, China

Signature

Shenzhen Jasic Technology Co Ltd

Position

Date



Company Stamp



STATEMENT OF WARRANTY

All new JASIC EVO20 welding, plasma cutters and multi-process machines are sold through our partner Wilkinson Star Limited within the United Kingdom and Ireland shall be warranted to the original owner, non transferable, against failure due to defective materials or production.

The warranty period is 5 years following the date of purchase and we recommend you register your product online within 28 days of purchase.

The original invoice is documentation for the standard warranty period. The warranty period is based on a single shift pattern.

Defective units shall be repaired or replaced by the company at our workshop. The company may opt to refund the purchase price (less any costs and depreciation due to use and wear).

The company reserves the right to alter the warranty conditions at any time with effect for the future.

A prerequisite for the full warranty is that products are operated in accordance with the operating instructions supplied, observing the relevant installation and any legal requirements recommendations and guidelines and carrying out the maintenance instructions shown in the operator manual. This should be carried out by a suitably qualified competent person.

Warranty claims will only be accepted from authorised Jasic distributors and in the unlikely event of a problem this should be reported to the technical support team to review the claim.

The customer has no claim to loan or replacement products whilst repairs are being performed.

The following falls outside the scope of the warranty:

- Defects due to natural wear and tear
- Failure to observe the operating and maintenance instructions
- Connection to an incorrect or faulty mains supply
- Overloading during use
- Any modifications that are made to the product without the prior written consent
- Software errors due incorrect operation
- Any repairs that are carried out using non-approved spare parts
- Any transport or storage damage
- Direct or indirect damage as well as any loss of earnings are not covered under the warranty
- External damage such as fire or damage due to natural causes e.g. flooding
- Warranty repairs carried out by non-authorised Jasic distributors.

NOTE: Under the terms of the warranty, welding torches, their consumable parts, wire feed unit drive rolls and guide tubes, work return cables and clamps, electrode holders, connection and extension cables, mains and control leads, plugs, wheels, coolant etc. are covered with a 3 month warranty.

Jasic shall in no event be responsible for any third party expenses or expenses/costs or any indirect or consequential expenses/costs.

Jasic will submit an invoice for any repair work performed outside the scope of the warranty. A quotation for any non warranty will be raised prior to any repairs being carried out.

The decision about repair or replacement of the defective part(s) is made by Jasic. The replaced part(s) remain(s) Jasic property.

Warranty extends only to the machine, its accessories and parts contained inside. No other warranty is expressed or implied. No warranty is expressed or implied in regards to the fitness of the product for any particular application or use.

If in our judgment you fail, or we suspect that you have failed, to comply with any term or provision of the product warranty terms, we reserve the right to deny you access to our services (or any part thereof).

For further information on Jasic product warranty terms and product warranty registration please visit:

www.jasic.co.uk/warranty-information

www.jasic.co.uk/warranty-registration

POWER SOURCE SCHEMATIC

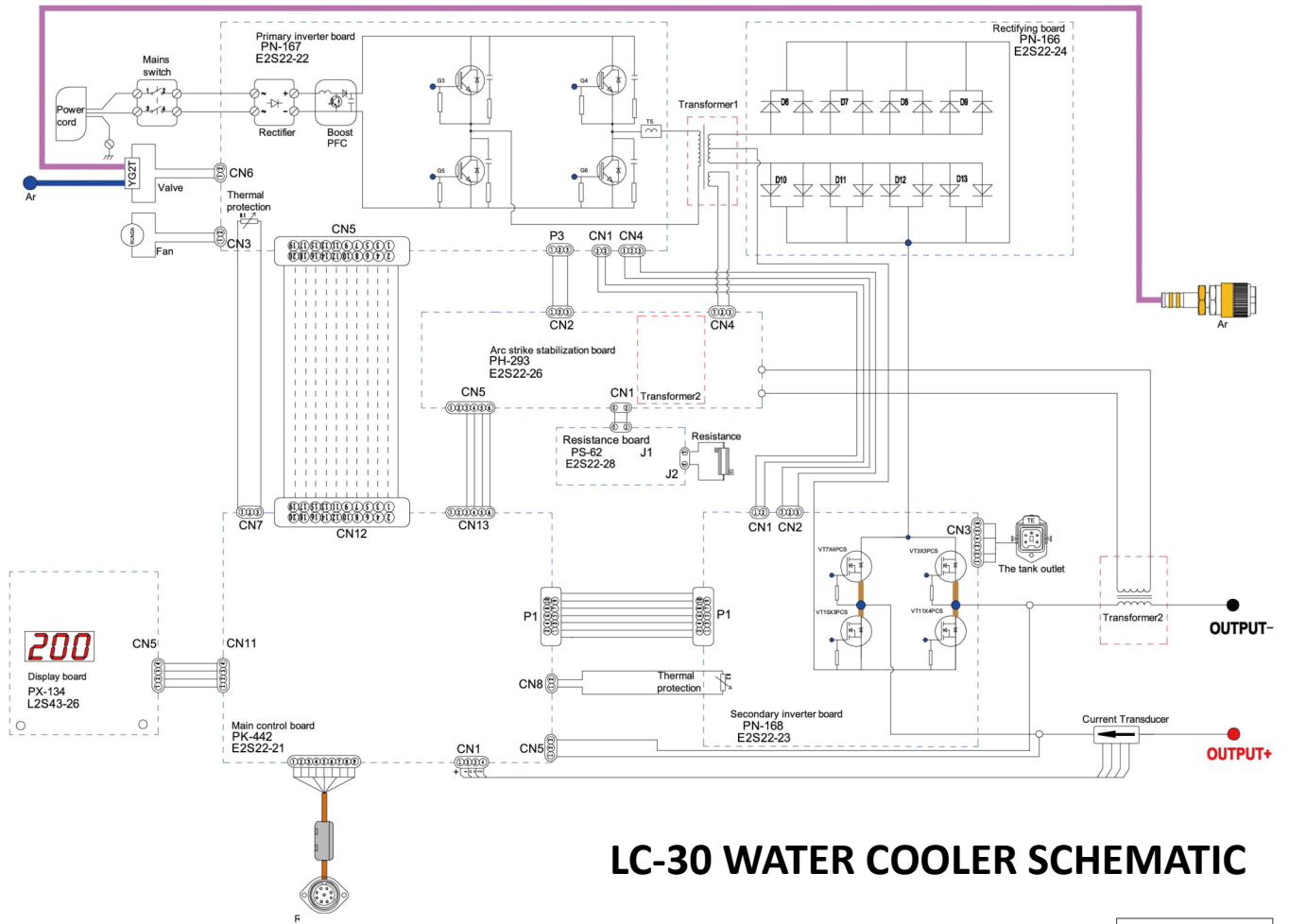

LC-30 WATER COOLER SCHEMATIC

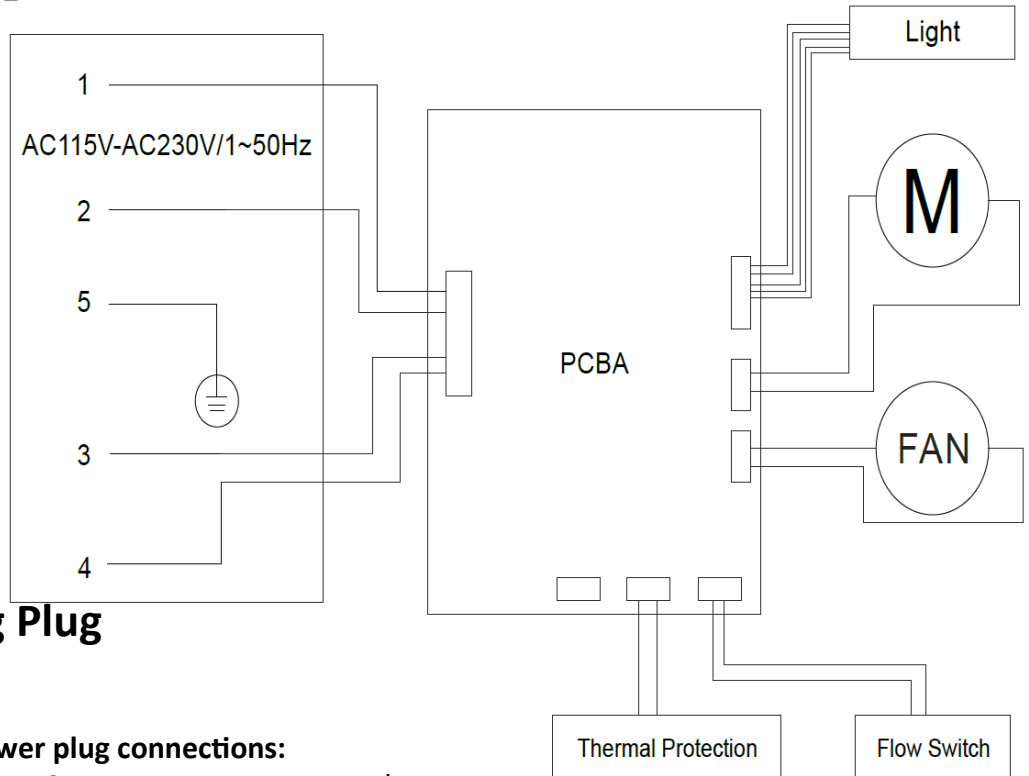

Cooler Connecting Plug

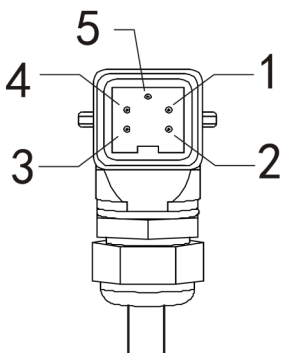

Power plug connections:

- Pins 1 & 2: AC115-230V 1~ 50/60Hz
- Pins 3 & 4: Fault signal
- Pin 5: Ground wire

DESCRIPTION OF WATER COOLER LC-30 (Supplied with ET-200PACDC-WC)

Overall view and technical details



Parameter	Unit	LC-30 Water Cooler
Rated input voltage	V	Single-phase AC 115-230V 15% 50/60Hz
Rated input power	W	AC 115 V @ 92w AC 230 V @ 115W
Volume of water tank	L	3.5
Maximum pressure	MPa	0.48
Maximum flow rate	L/min	4
Rated cooling power	KW	0.52 (1L/min)
Protection class	-	IP23S
Executive standard	-	EN IEC 60974-2/BS EN IEC60974-2
Coolant	-	Pure water, anti-freezing solution, mixed liquid
Operating ambient temperature	°C	Mixed liquid, pure water: 5 ~ 60 Anti-freezing solution: -20 ~ 60

Jasic LC-30 water cooler

1. Power and control plug and cable
2. Water outlet (cold) connect the blue red TIG torch supply water hose to this connector
3. Water return (hot) connect the red TIG torch return water hose to this connector
4. Filler cap for coolant, remove to fill water/coolant tank
5. LC-30 Cooler indicators
 - Top - Power LED
 - Middle - Flow warning LED
 - Bottom - Overheat warning LED
6. Coolant min and max level indicator
7. Coolant drain plug cap, remove to drain the coolant tank.

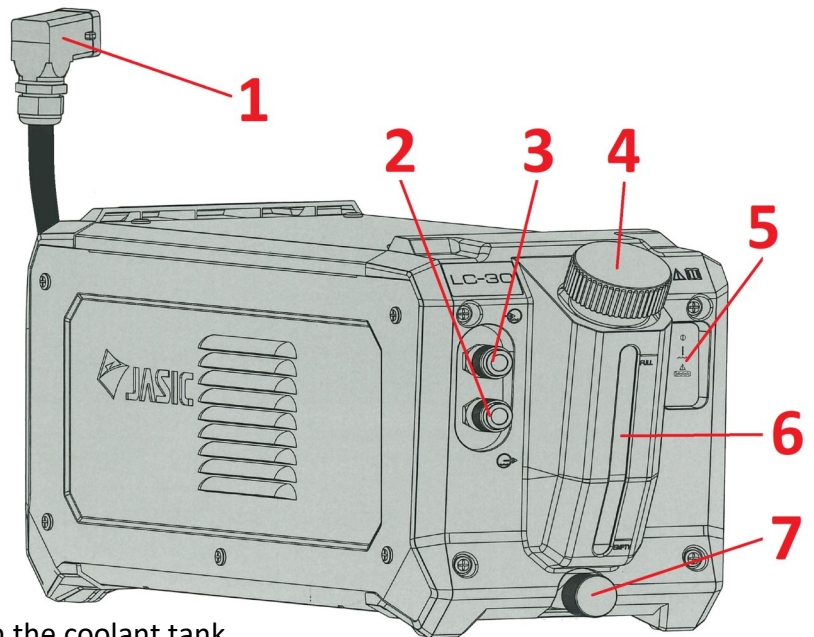

Water (coolant) level:

The coolant level should always be maintained and should never drop below the minimum level line, over heating of the TIG torch will occur if the level is low and damage may be caused.

Do not over fill the water tank with coolant

Coolant drainage:

Coolant can be drained easily by un-screwing and removing the front drain plug (item No 7) in the above image.





- Please ensure to add coolant (cooling water) when the input cable is disconnected from the power supply.
- The two filter screen in the water filling cap (4 as above) cannot be removed. If unfiltered coolant is added, impurities may block the waterway system and consequently the machine or TIG torch may be damaged.

Please Note: For further information regarding the LC-30 water cooler, please see page 32 of this manual or check the LC-30 water cooler operating manual.

OPTIONS AND ACCESSORIES

Part Number	Description
JE79-ERGO	26 TIG Torch, 12.5ft, TIG Torch c/w Plug (air cooled)
JE83-ERGO	18 TIG Torch, 12.5ft, TIG Torch c/w Plug (water Cooled)
WCS25-3WEL	Welding Cable Set (MMA) 3m
WC-2-03LD	Electrode Holder and lead 3m
EC-2-03LD	Work Return Lead and Clamp 3m
CP3550	Cable Plug 35-50mm
JH-HDX	Jasic HD True Colour Auto Darkening Welding Helmet
HRC-01	Wired hand held remote current control
HRC-02	Wireless hand held remote current control
FRC-01	Wired foot pedal remote current control
FRC-02	Wireless foot pedal remote current control
TS4	Wireless Transceiver
LC-30	Optional Cooler LC-30
TR-01	Optional Trolley 2 Wheel with Toolbox (for water cooled setup only)
TR-02	Optional Trolley 2 Wheel without Toolbox (for water cooled setup only)

OPTIONAL REMOTE CONTROL DEVICES

Control Type	Name	Model	Wireless Receiver	Welding Mode	Image
Wired	Analog TIG torch trigger	10K potentiometer TIG Torch	N/A	TIG	-
	Digital TIG torch trigger	Digital TIG Torch	N/A	TIG	-
	Wired foot pedal remote control	FRC-01	N/A	TIG	
	Wired handheld remote control	HRC-01	N/A	TIG/MMA	
Wireless	Wireless handheld remote control	HRC-02	Yes	TIG/MMA	
	Wireless Foot pedal remote control	FRC-02	Yes	TIG	
	Wireless Transceiver	TS4	Yes	TIG/MMA	N/A



Wilkinson Star Limited

Shield Drive
Wardley Industrial Estate
Worsley
Manchester
UK
M28 2WD

+44(0)161 793 8127



Jasic.co.uk

 **JASIC®** | Passionate About Your Welding

www.jasic.co.uk

February 2024 Issue 4